



XTA Electronics Ltd.
Vale Business Park,
Worcester Road,
Stourport-on-Severn,
Worcestershire
DY13 9BZ
England

Tel: +44(0)1299 879977
Fax: +44(0)1299 879969
www.xta.co.uk



© XTA Electronics Ltd 2019

Designed & written by Waring Hayes 11.19
For comments, suggestions, errors or omissions, please
contact XTA at the address above, or email info@xta.co.uk

CONTENTS

DECLARATION OF CONFORMITY	5
THANKS	6
INTRODUCTION	6
IMPORTANT SAFETY INSTRUCTIONS	7
INSTRUCTIONS DE SECURITE IMPORTANTES	8
Installing Your MX36: Unpacking.....	9
Additional Symbols and Warnings	9
Installation Electrical Considerations	10
Installation Mechanical Considerations	11
Connecting To Your MX36: Analogue Line Inputs and Outputs	12
Operating Your MX36: Initial Set-up and Switching On	13
Operating Your MX36: The Basics.....	14
Outside Your MX36: Front Panel Controls and Indicators.....	15
Local Mic / Stereo Line Inputs	15
Input / Backup Source Select	17
Console Select.....	18
Line Monitoring	19
Outside Your MX36: Rear Panel Connections	21
Inside Your MX36: Configurations and Routing	22
Overview of Audio Routing	22
Operating Your MX36: Working with Failover and Redundancy.....	24
Operating Your MX36: With and/or Without Redundancy.....	25
Example Setup	25
Conditions That Trigger a Source Change in Redundancy Mode	26
If a Source is Restored.....	26
Working without Redundancy	27
Operating Your MX36: Headroom Monitoring System	28
Operating Your MX36: GPI Configuration for Voice Evac. Systems	29
Configuring the GPI port	29
Connecting to the GPI port.....	31
Operating Your MX36: Increase Console Capacity with Cascade Mode	32
Configuring Cascade Mode within Dante Controller	33
Operating Your MX36: Increase Channel Capacity with Parallel Mode	37

Looking After Your MX36: Maintenance	38
Looking After Your MX36: Warranty	38
Performance Of Your MX36: Specifications.....	39
Appendix I: Microphone and Stereo Line Input DSP Filter Responses.....	40
Appendix II: Upgrading Firmware.....	41
Communications Set-up	41
Download the Files	41
Connect To The Unit.....	42
Start the Update.....	42
What If It All Goes Wrong.....	43
Appendix III: Dante I-O Channels Mapping	44
Appendix IV: AES options configuration	45
Configuring the GPI port	45

DECLARATION OF CONFORMITY

We, the manufacturer:

**XTA Electronics Limited,
The Design House
Vale Business Park
Worcester Road
Stourport on Severn
Worcestershire
England
DY13 9BZ**

acknowledge our responsibility that the following products:

**Kind of equipment: Digital Signal Processing Apparatus
Commodity Code: 85437006
Type Designation: MX36
and all variants of this model**

are manufactured:

in accordance with EMC Directive 2004/108/EC,
in compliance with the following norm(s) or document(s):
Technical Regulations: EN55103-1:1996, EN55103-2:1996

and

in accordance with the Low Voltage Directive 2006/95/EC,
in compliance with the following norm(s) or document(s):
Technical Regulations: EN/IEC60065:2002 7th Edition

Signed:

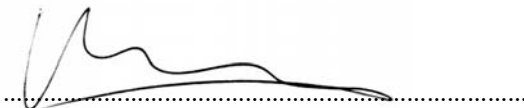

Name: Alex Cooper
Position: Research and Development Manager
Date: June 2019



THANKS

Thank you for choosing an MX36 console switcher for your application. Please spend a little time reading through this manual, so that you obtain the best possible performance from the unit and become familiar with its operating requirements.

All XTA products are carefully designed and engineered for cutting-edge performance and world-class reliability. If you would like further information about this or any other XTA product, please contact us.

We wish you many years of service from this product and look forward to hearing from you in the near future.



INTRODUCTION

The MX36 has been designed to offer a uniquely simple solution to the long-standing problem of routing of multiple mixing consoles outputs to a speaker system / system processor. Handling 36 inputs in 2U across analogue, AES and Dante networks, these are arranged in sets of four (to typically support Left-Right-Front Fill and Sub feeds from an individual console). All AES inputs have SRC. There is one set of four outputs, available simultaneously across analogue, AES and Dante networks with Word Clock output sync available on AES.

All switching takes place in the digital domain with soft cross-fades primarily to switch up to three consoles, each with up to three levels of redundancy. The primary and secondary sources may be selected depending on the availability of support on the console (so AES or Dante, or even just analogue) and the MX36 will automatically select the secondary source should the primary fail.

If failover with redundancy is not required, then the MX36 can handle up to 9 consoles (accommodating 3 each on analogue, AES and Dante feeds).

In addition to the quad channel sets for the consoles, there is a fully featured high quality mono mic preamp for "Voice of God" announcements. This has selectable routing, as well as clarity filtering in DSP, and switchable 48v phantom power.

There is also a stereo line input, again with "sweetening" filtering, selectable routing, and fully balanced rear inputs, plus an unbalanced 3.5mm jack front panel input.

As important as the extensive switching and automatic routing capabilities, the MX36 also has full headphone monitoring of EVERY line individually with extended metering.

Dante allows for units to operate in either cascade or parallel modes to extend the input set sizes or number of consoles that may be simultaneously switched,

All of this is fully user configurable via the front panel – no need to connect a computer or depend on an app with a wireless connection.



IMPORTANT SAFETY INSTRUCTIONS



CAUTION: RISK OF ELECTRIC SHOCK. DO NOT OPEN



The lightning flash with arrowhead symbol within an equilateral triangle is intended to alert the user to the presence of uninsulated "dangerous voltage" within the product's enclosure that may be of sufficient magnitude to constitute a risk of electric shock to persons.



The exclamation mark within an equilateral triangle is intended to alert the user of important operating and maintenance (servicing) instructions in the literature accompanying the appliance.

WARNING: Apparatus with CLASS I construction shall be connected to a MAINS socket outlet with a protective earthing connection.

WARNING: To prevent injury, this apparatus must be securely attached to the rack in accordance with the installation instructions.

1. Read these instructions.
2. Keep these instructions.
3. Heed all warnings.
4. Follow all instructions.
5. Do not use this apparatus near water.
6. Clean only with a dry cloth.
7. Do not block any ventilation openings, install in accordance with the manufacturer's instructions.
8. Do not install near any heat sources, such as radiators, heat registers, stoves or other apparatus (including amplifiers) that produce heat.
9. Do not defeat the safety purpose of the polarized or grounding-type plug. A polarized plug has two blades with one wider than the other. A grounding-type plug has two blades and a third grounding prong. The wide blade or the third prong are provided for your safety. If the provided plug does not fit into your outlet, consult an electrician for replacement of the obsolete outlet.
10. Protect the power cord from being walked on or pinched particularly at plugs, convenience receptacles and the point where they exit from the apparatus.
11. Only use attachments/accessories specified by the manufacturer.



12. Use only with the cart, tripod, bracket or table specified by the manufacturer, or sold with the apparatus. When a cart is used, use caution when moving the cart/apparatus combination to avoid injury from a tip over.

13. Unplug this apparatus during lightning storms or when unused for a long period of time.

14. Refer all servicing to qualified service personnel. Servicing is required when the apparatus has been damaged in any way, such as if the power-supply cord or plug is damaged, liquid has been spilled or objects have fallen into the apparatus, the apparatus has been exposed to rain or moisture, does not operate normally, or has been dropped. This equipment contains a non-user replaceable lithium battery for memory retention. Should this battery fail and user settings be lost, do not attempt to replace the battery yourself but return the equipment to an authorised service centre.

15. Do not expose this equipment to dripping or splashing and ensure that no objects filled with liquids, such as vases, are placed on the equipment.

16. To completely disconnect this equipment from the AC mains, disconnect the power cord from the mains circuit breaker.

17. This unit is fitted with a 3-wire power cord. For safety reasons, THE EARTH LEAD SHOULD NOT BE DISCONNECTED IN ANY CIRCUMSTANCE.



18. Correct disposal of this product: This symbol indicates that this product must not be disposed of with household waste, according to the WEEE Directive (2012/19/EU) and your national law. This product should be taken to a collection center licensed for the recycling of waste electrical and electronic equipment (EEE). The mishandling of this type of waste could have a possible negative impact on the environment and human health due to potentially hazardous substances that are generally associated with EEE. At the same time, your cooperation in the correct disposal of this product will contribute to the efficient use of natural resources. For more information about where you can take your waste equipment for recycling, please contact your local city office, or your household waste collection service.

INSTRUCTIONS DE SECURITE IMPORTANTES

**ATTENTION: RISQUE DE CHOC ELECTRIQUE.
NE PAS OUVRIR**

Le symbole représentant un éclair fêché dans un triangle équilatéral a pour but d'alerter l'utilisateur de la présence d'une "tension dangereuse" non isolée à l'intérieur du boîtier, pouvant être d'une force suffisante pour constituer un risque d'électrocution.



Le point d'exclamation dans un triangle équilatéral a pour but d'alerter l'utilisateur de la présence d'instructions importantes concernant le fonctionnement et la maintenance, dans la documentation qui accompagne l'appareil.

ATTENTION: Appareils de construction de CLASSE I doit être raccordé au réseau électrique via une prise de courant reliée à la terre.

ATTENTION: Pour éviter toute blessure, cet appareil doit être solidement fixé à la torture, conformément aux instructions d'installation.

1. Lisez ces consignes.
2. Conservez ces consignes.
3. Respectez tous les avertissements.
4. Respectez toutes les consignes d'utilisation.
5. N'utilisez jamais l'appareil à proximité d'un liquide.
6. Nettoyez l'appareil avec un chiffon sec.
7. Veillez à ne pas empêcher la bonne ventilation de l'appareil via ses ouïes de ventilation. Respectez les consignes du fabricant concernant l'installation de l'appareil.
8. Ne placez pas l'appareil à proximité d'une source de chaleur telle qu'un chauffage, une cuisinière ou tout appareil dégageant de la chaleur (y compris un ampli de puissance).
9. Ne supprimez jamais la sécurité des prises bipolaires ou des prises terre. Les prises bipolaires possèdent deux contacts de largeur différente. Le plus large est le contact de sécurité. Les prises terre possèdent deux contacts plus une mise à la terre servant de sécurité. Si la prise du bloc d'alimentation ou du cordon d'alimentation fourni ne correspond pas à celles de votre installation électrique, faites appel à un électricien pour effectuer le changement de prise.
10. Installez le cordon d'alimentation de telle façon que personne ne puisse marcher dessus et qu'il soit protégé d'arêtes coupantes. Assurez-vous que le cordon d'alimentation est suffisamment protégé, notamment au niveau de sa prise électrique et de l'endroit où il est relié à l'appareil; cela est également valable pour une éventuelle rallonge électrique.
11. Utilisez exclusivement des accessoires et des appareils supplémentaires recommandés par le fabricant.
12. Utilisez exclusivement des chariots, des diables, des présentoirs, des pieds et des surfaces de travail recommandés par le fabricant ou livrés avec le produit. Déplacez précautionneusement tout chariot ou diable chargé pour éviter d'éventuelles blessures en cas de chute.
13. Débranchez l'appareil de la tension secteur en cas d'orage ou si l'appareil reste inutilisé pendant une longue période de temps.
14. Les travaux d'entretien de l'appareil doivent être effectués uniquement par du personnel qualifié. Aucun entretien n'est nécessaire sauf si l'appareil est endommagé de quelque façon que ce soit (dommages sur le cordon d'alimentation ou la prise par exemple), si un liquide ou un objet a pénétré à l'intérieur du châssis, si l'appareil a été exposé à la pluie ou à l'humidité, s'il ne fonctionne pas correctement ou à la suite d'une chute. Pour la mémorisation des paramètres, cet appareil contient une pile au lithium non remplaçable par l'utilisateur. En cas de défaillance de la pile et perte des réglages, n'essayez pas de remplacer la pile par vous-même. Retourner votre appareil vers une station technique habilitée.
15. N'exposez pas cet équipement au fait de tomber goutte à goutte ou au fait d'éclabousser et garantisiez qu'aucun objet rempli des liquides, comme les vases, n'est placé sur l'équipement.
16. Pour complètement débrancher cet équipement de la conduite principale de courant alternatif, débranchez la corde de pouvoir du disjoncteur de conduite principale.
17. Cette unité est correspondue avec une corde de pouvoir de 3 fils. Pour les raisons de sécurité, L'AVANCE DE TERRE NE DEVRAIT ÊTRE DÉBRANCHÉE DANS AUCUNE CIRCONSTANCE.
18. Mise au rebut appropriée de ce produit: Ce symbole indique qu'en accord avec la directive DEEE (2012/19/EU) et les lois en vigueur dans votre pays, ce produit ne doit pas être jeté avec les déchets ménagers. Ce produit doit être déposé dans un point de collecte agréé pour le recyclage des déchets d'équipements électriques et électroniques (EEE). Une mauvaise manipulation de ce type de déchets pourrait avoir un impact négatif sur l'environnement et la santé à cause des substances potentiellement dangereuses généralement associées à ces équipements. n même temps, votre coopération dans la mise au rebut de ce produit contribuera à l'utilisation efficace des ressources naturelles. Pour plus d'informations sur l'endroit où vous pouvez déposer vos déchets d'équipements pour le recyclage, veuillez contacter votre mairie ou votre centre local de collecte des déchets.



Installing Your MX36: Unpacking

After unpacking the unit, please check it carefully for any damage. If any is found, immediately notify the carrier concerned - you, the consignee, must instigate any claim. Please retain all packaging in case of future re-shipment.

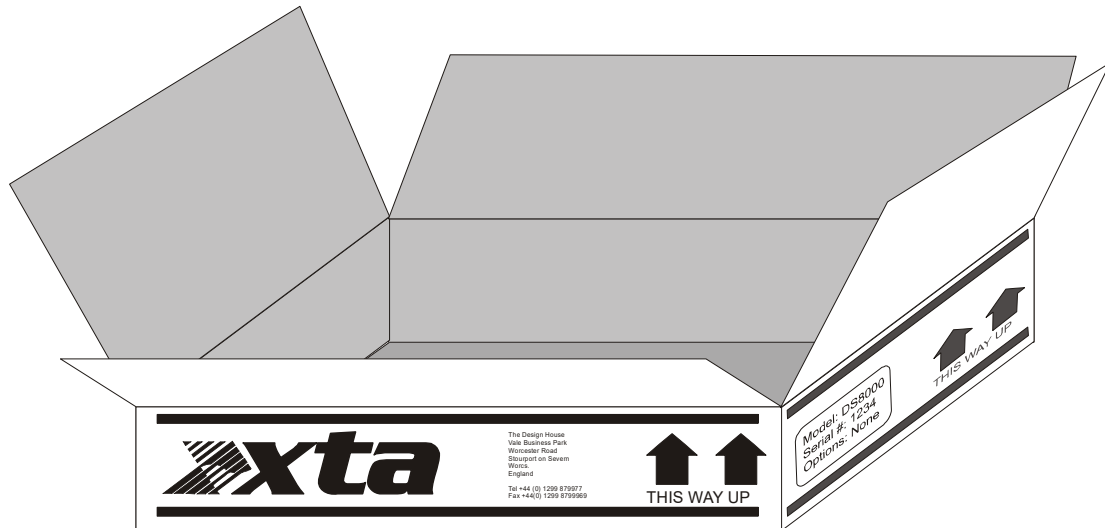

Additional Symbols and Warnings



只有在高海拔地区使用不超过2000米。

Meaning of the symbol: Evaluation for apparatus only based on altitude not exceeding 2000m, therefore it is the only operating condition applied for the equipment. There may be some potential safety hazard if the equipment is used at altitude above 2000m.



只适合于非热带气候地区使用

Meaning of the symbol: Evaluation for the apparatus only based on temperate climate condition, therefore it is the only operating condition applied for the equipment. There may be some potential safety hazard if the equipment is used in tropical climate region,

Installation Electrical Considerations

The MX36 has been manufactured to comply with your local power supply requirements, but before connecting the unit to the supply, ensure that the voltage (printed on the rear panel) is correct.

The MX36 is fitted with a pair of universal power supplies that operate in a dual redundant configuration – should either one fail or become disconnected, the other supply is fully capable of operating the unit indefinitely.

Make sure power outlets conform to the power requirements listed on the back of the unit. Damage caused by connecting to improper AC voltage is not covered by the warranty.

SAFETY WARNING

Where a MAINS plug or appliance coupler is used as the disconnect device, it should remain readily operable.

For safety reasons,

THE EARTH LEAD SHOULD NOT BE DISCONNECTED IN ANY CIRCUMSTANCE.

If ground loops are encountered consult the section on connecting your unit on page 12.

The wiring colours are:

230V AREAS: EARTH = GREEN AND YELLOW
NEUTRAL = BLUE
LIVE = BROWN

DO NOT USE THE UNIT IF THE ELECTRICAL POWER CORD IS FRAYED OR BROKEN. The power supply cords should be routed so that they are not likely to be walked on or pinched by items placed upon or against them, paying particular attention to cords and plugs and the point where they exit from the appliance.

ALWAYS OPERATE THE UNIT WITH THE AC GROUND WIRE CONNECTED TO THE ELECTRICAL SYSTEM GROUND. Precautions should be taken so that the means of grounding of a piece of equipment is not defeated.

DO NOT REMOVE THE LID. Removing the lid will expose you to potentially dangerous voltages. There are no user serviceable parts inside.

ESD strikes to the unit's front panel that are in excess of 4000 volts may cause disturbance to the status LEDs on the unit. This will not affect audio performance and will be corrected on the next power up cycle.



Installation Mechanical Considerations

To ensure that this equipment performs to specification, it should be mounted in a suitable rack or enclosure as described below. Like all sensitive signal processing equipment, it should be kept away from other equipment which is sensitive to magnetic fields. Also, this unit may suffer a substantial reduction in performance if it is subjected to or mounted close to equipment which radiates high RF fields.

Warning: To prevent injury, this apparatus must be securely attached to the rack in accordance with the installation instructions

When mounting in a rack or enclosure:

- Ensure that there is adequate ventilation.
- Make sure that the rack unit has a separate earth connection (technical earth).
- Please also see the notes regarding maintenance on page 38.

Connecting To Your MX36: Analogue Line Inputs and Outputs

The inputs are made via 3-pin XLR connectors, which are electronically balanced and should be connected via a high-grade twin core screened cable, as follows:



PIN1: Screen (see note below)
 PIN2: Hot (signal +)
 PIN3: Cold (signal -)

The unit is designed to operate with fully balanced equipment and ground loops or loss of performance may be experienced if connected to unbalanced sources. If it is unavoidable however, the following wiring should be used. The cable should still be twin core plus screen.

PIN1: Screen - connected to the chassis of the unbalanced equipment - or left disconnected at the unbalanced end.
 PIN2: Hot (signal +)
 PIN3: Cold (ground 0V)

NOTE: This unit is wired to the latest industry recommendations. PIN1 is connected directly to the chassis/mains earth. If ground loops (mains hum) are encountered remove the screen connection from the other end of the cable and leave it open circuit. If problems persist, consult your dealer/supplier.

DO NOT TAMPER WITH OR ALTER ANY GROUND (EARTH) CONNECTIONS INSIDE THE UNIT.

Additionally, there is a front panel unbalanced stereo 3.5mm jack socket for connection to a line source (such as a laptop/tablet/mobile phone).

3.5mm
STEREO

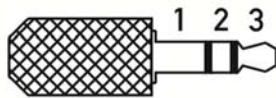

1: Screen
 2: Left
 3: Right

Outputs are also made via 3-pin XLR connectors wired as follows:

XLR
FEMALE

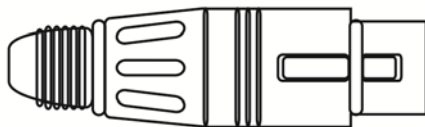

PIN1: Screen (see note above)
 PIN2: Hot (signal +)
 PIN3: Cold (signal -)

Note that the rear panel outputs are electronically balanced and so are not galvanically (electrically) isolated. Front panel outputs are transformer balanced and so are isolated.

The headphone socket (6.4mm) is stereo, but audio is always mono – do NOT use a mono jack as the output is floating:

6.4mm
STEREO

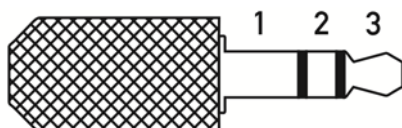

1: Screen
 2: Left (mono)
 3: Right (mono)

Operating Your MX36: Initial Set-up and Switching On

Please read all documentation before operating your unit and retain all documentation for future reference.

Do not spill water or other liquids into or on the unit and do not operate your unit while standing in liquid.

Do not ventilation outlets or operate the unit in an environment that could impede the free flow of air around the unit.

If your unit is used in an extremely dusty or smoky environment, it should be cleaned of any collected debris at regular intervals. Please also see the notes regarding maintenance on page 38.

Switching On...

The previous settings of all controls will be recalled, and the audio will fade up after initial boot-up. Note that if the outputs are being fed from a Dante source, this will take longer to reconnect than analogue and AES sources and may start suddenly (after the output fade).

A note about the analogue controls

As these are normal potentiometers and not rotary encoders, their physical position determines their setting. As it's entirely possible they may have been adjusted when the unit is powered down, be aware that their new position will be used when next powered up, so please check the gains and headphones level before engaging!

Operating Your MX36: The Basics

- 1) Connect a source of up to four channels to inputs A or B or C on the rear – any format (analogue, AES or Dante via the Network Audio Ethernet ports). In the case of Dante inputs, make sure they are correctly subscribed from the upstream device. A list of all the Dante channel names is in Appendix III on page 44.

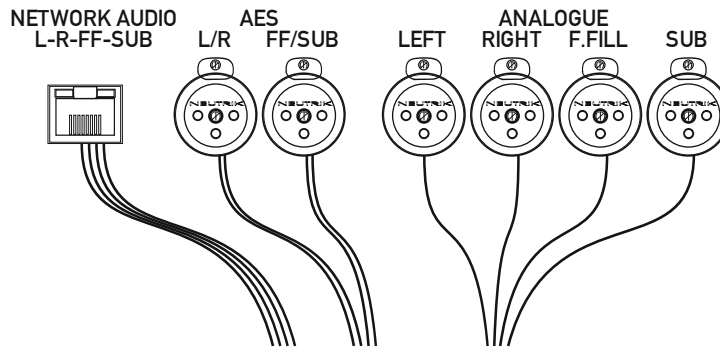

- 2) For the chosen input sets, A or B or C, make sure the correct input source has been selected in the PRIMARY Input Source section on the front panel. Make sure the BACKUP Source Selection is set to OFF (if the button is not illuminated, that is because the PRIMARY source has been set to Analogue – this is by design).

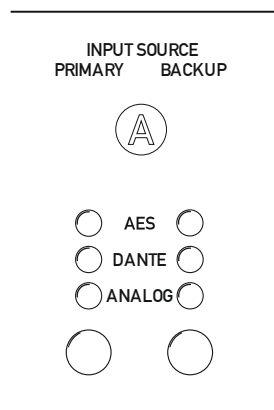

- 3) If the Input Source Select button starts to flash, the chosen digital source is not connected correctly – see page 26 for more information.
- 4) Connect up to four outputs of any format (Analogue, AES or Dante) to the downstream device (amplifiers or system processor). In the case of a Dante connection, ensure that the channels are correctly subscribed through Dante Controller.
- 5) If required, plug in headphones and use the Line Monitoring section to check the integrity of the connected sources by sequencing through the input sets' sources and individual channels – the meter shows the input level.
- 6) Press the Console Select sections A or B or C buttons to switch the source channels to the outputs. The selections are not mutually exclusive so more than one can be active.

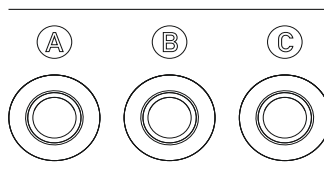

And that's it! You should now be able to switch between different sets of inputs through to the main outputs!

Outside Your MX36: Front Panel Controls and Indicators

Local Mic / Stereo Line Inputs

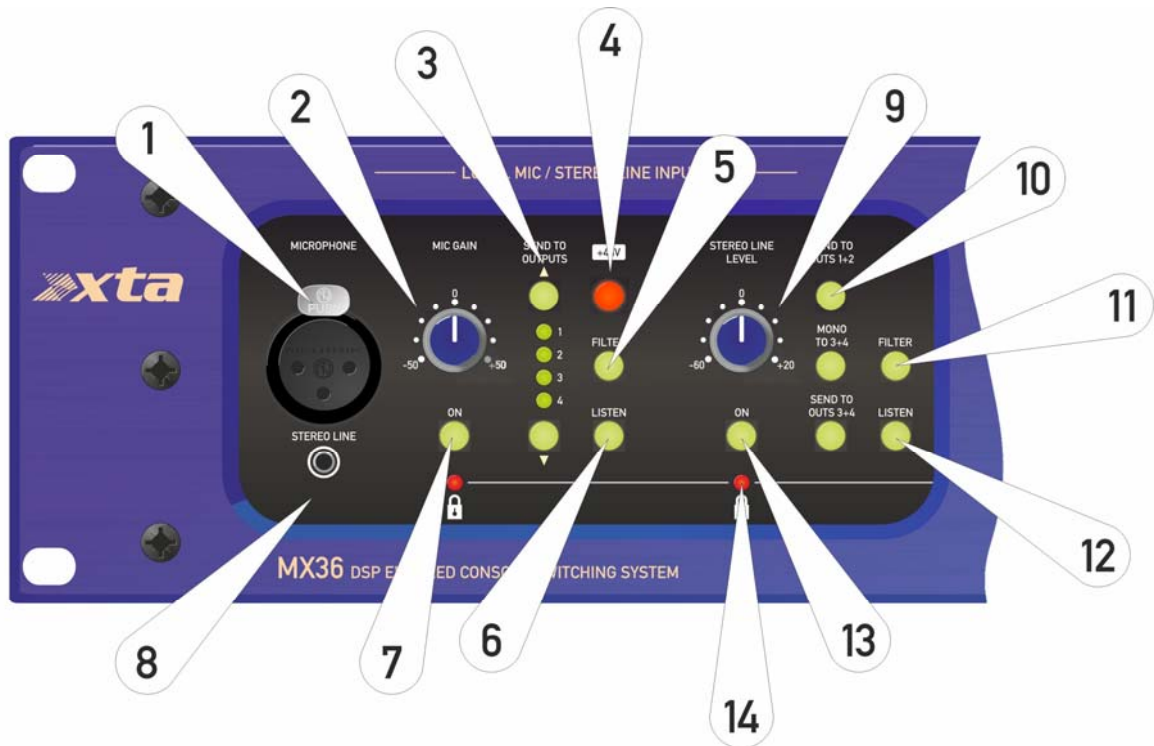

- 1: Microphone Input: Plug in a balanced mic to use for announcements – this socket is mirrored on the rear panel (both sockets are connected in parallel).
- 2: Microphone Gain: The gain range has been designed to cater for passive, active and wireless mic systems. The 12 o'clock position is 0dB gain and should be used when connected to the output of a wireless microphone receiver. Turn the control clockwise from 12 o'clock to increase the gain for use with passive microphones. Turn the control anti-clockwise from 12 o'clock to adapt the input to line levels.
- 3: Microphone Send to Outputs Selects: Use the up and down buttons to cycle through preset routings to the main outputs, as shown on the LED column.
- 4: 48V phantom power: Press and HOLD to enable phantom power on both front and rear mic XLR sockets. Phantom power cannot be disabled/enabled if the Mic is ON – switch output off first to change state. (The green Mic ON button will flash if 48V is held in and the mic is turned on).
- 5: Microphone Filter: Enable a high pass filter and sweetening EQ for the mic input. This effect can be previewed via the listen function. The filter's response is shown in Appendix I on page 40.
- 6: Microphone Listen: Press to hear the microphone signal through the headphones. Set the gain accurately by using the meter in Line Monitor section. Note that this will interrupt the current line signal being monitored. The button will flash to show this is active.
- 7: Microphone ON: Toggle the Microphone signal to the outputs as selected by 3.

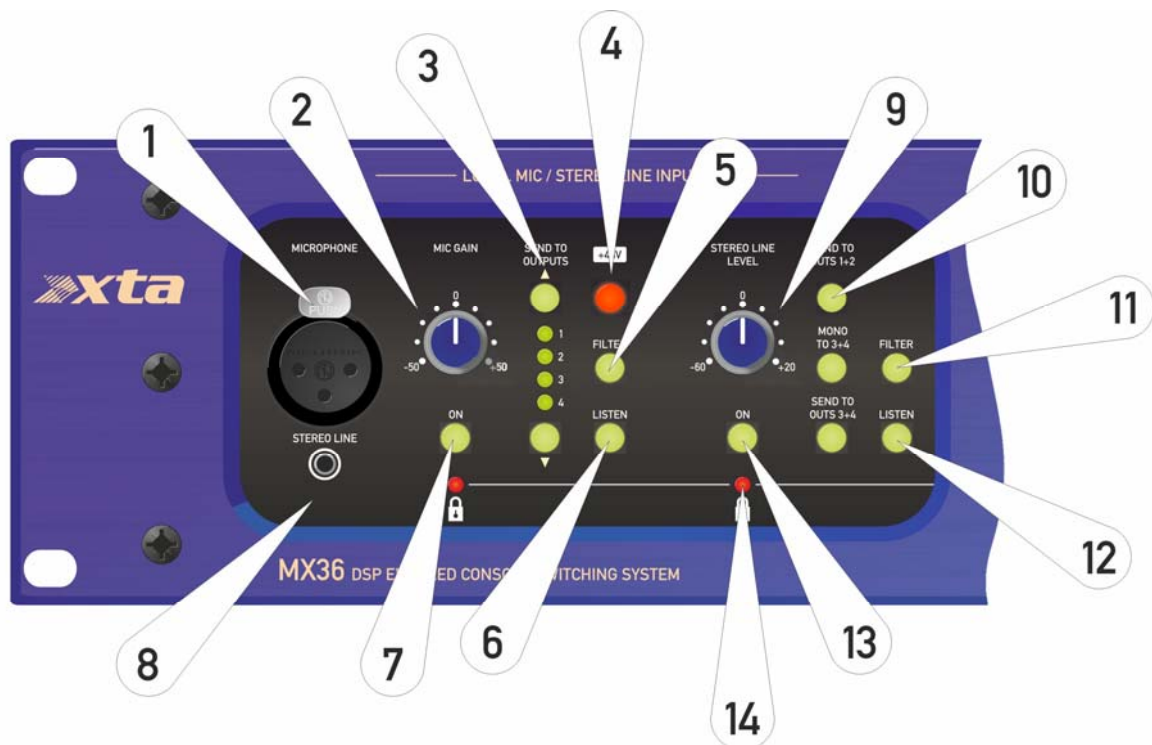

8: Stereo Line Input: This unbalanced stereo input is mirrored on the rear panel with a pair of fully balanced XLR inputs. Use to connect a laptop or mobile sourced sound source for background music feeds, or even another stereo console.

9: Stereo Line Level: The gain range has been designed to act like a “fader” so this can be used for accurate control of background music level. The minimum position is “OFF” and the 12 o’clock position is 0dB.

10: Stereo Line Send to Outs Selection: 1+2: Toggle whether the stereo input will be sent to main outputs 1+2 when the ON button is enabled. 3+4 / Mono to 3+4: These two buttons are mutually exclusive and will send either a stereo feed to main outputs 3+4, or a mono sum of the stereo signal to 3+4.

11: Stereo Line Filter: Enable a high pass filter to prevent excessive LF from background music sources. This effect can be previewed via the listen function. The filter’s response is shown in Appendix I on page 40.

12: Stereo Line Listen: Press to hear a mono mix of the stereo line feed through the headphones. Set the gain accurately by using the meter in Line Monitor section. Note that this will interrupt the current line signal being monitored. The button will flash to show this is active.

13: Stereo Line ON: Toggle the Stereo Line signal to the outputs as selected by buttons 5.

14: Locked/Safe LED: If the padlock button is active, the corresponding locked/safe LEDs show which sections cannot be adjusted. Only the LISTEN buttons remain operative when the panel is locked.

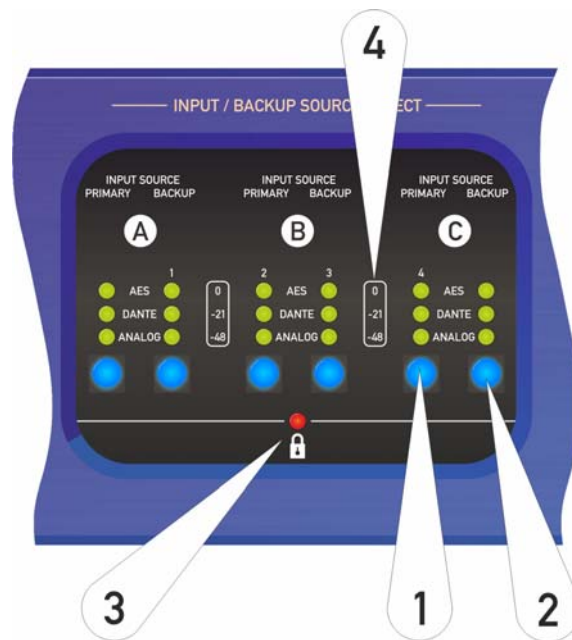
Input / Backup Source Select

1: Primary Input Source Selections: Choose Analogue, AES or Dante for the main source for each input set (A/B/C). Works in conjunction with 2.

2: Backup Source Selection: Choose a backup source which will be automatically routed to the particular set's outputs (pre-console selects) should the primary source fail. There is an OFF state if redundancy/failover operation is not required on this set. Not available if primary source is analogue.

3: Locked/Safe LED: If the padlock button is active, the corresponding locked/safe LEDs show which sections cannot be adjusted. All Line Monitoring functions always remain accessible, as do the Listen functions in the MIC / Line section.

4: Meter Outs Scaling: When the METER OUT button is enabled, the middle four columns of LEDs show real time output levels for the main outputs as designated by these labels. Pressing any source select button will cancel this and switch back to show input source selections.

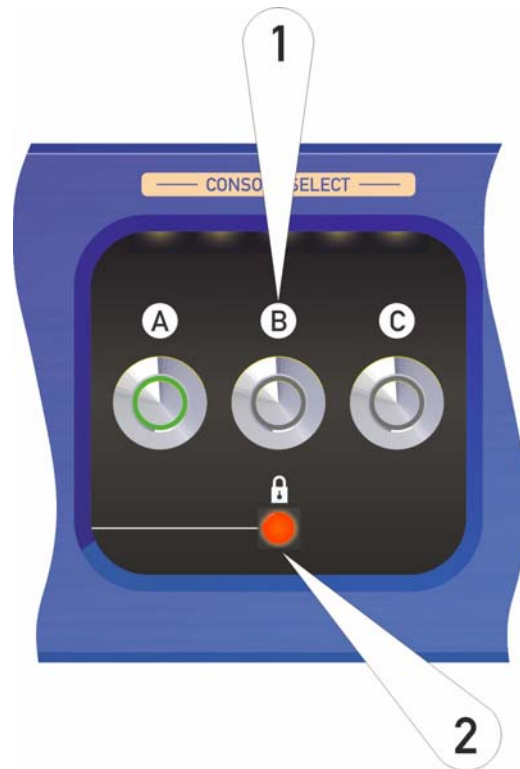
Console Select

1: Console Select: The Main Event! These three switches route the output of each quad channel set (depending on the Primary/Backup source settings for each set) to the main outputs. They may be mixed (so more than one may be active) and there is a brief programmed fade on enable/disable.

2: Lock/Safe: Press and HOLD to disable adjustment on all panel sections with the red locked/safe LEDs. All Line Monitoring functions always remain accessible, as do the Listen functions in the MIC / Line section.

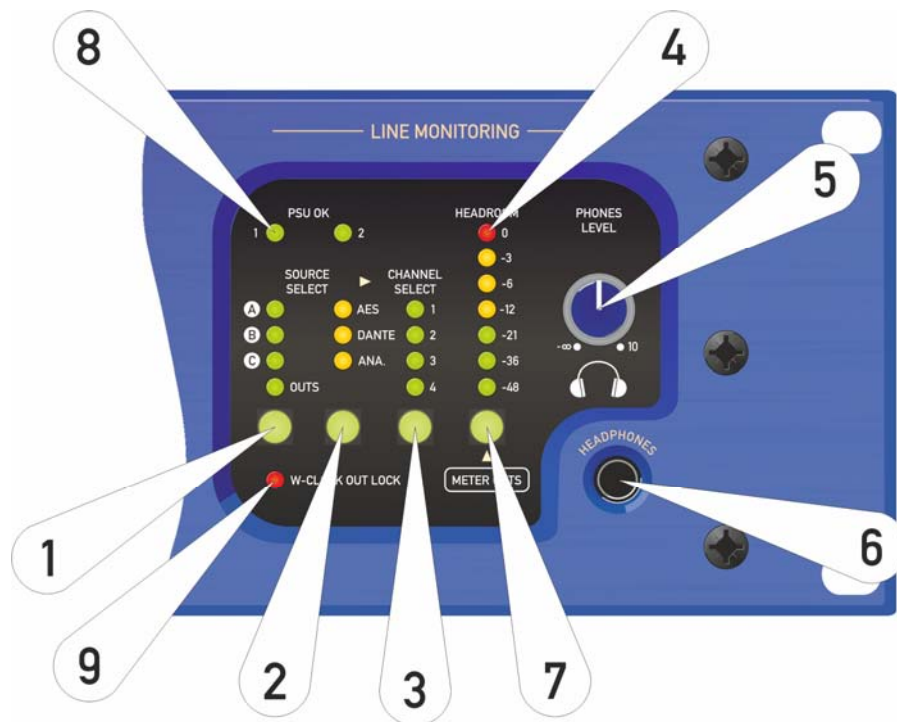
Line Monitoring

1: Source Select: Choose to monitor the A, B or C input sets, or the final outputs (monitor point in green in diagram below) and then...

2: Type Select: ...chosen source type (Dante, AES, Analogue) for the set. When "OUTS" is selected, source type is disabled as all three types are fed simultaneously. There is an "OFF" state for this selection which selects monitoring from the "Pre Console Select" points in red in the signal path as below:

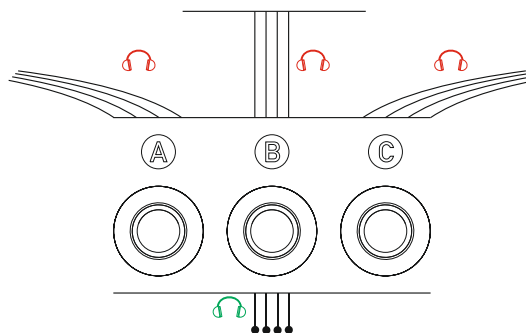

This point allows monitoring of the actual choice of Primary and Failover selections and verification that the failover is working as expected (by deliberately disconnecting/inducing a failover situation and listening to the swap to the backup source).

3: Channel Select:...within the chose A/B/C (or outputs), the channel from the set.

4: Headroom Meter: This meter shows the level of the currently selected channel.

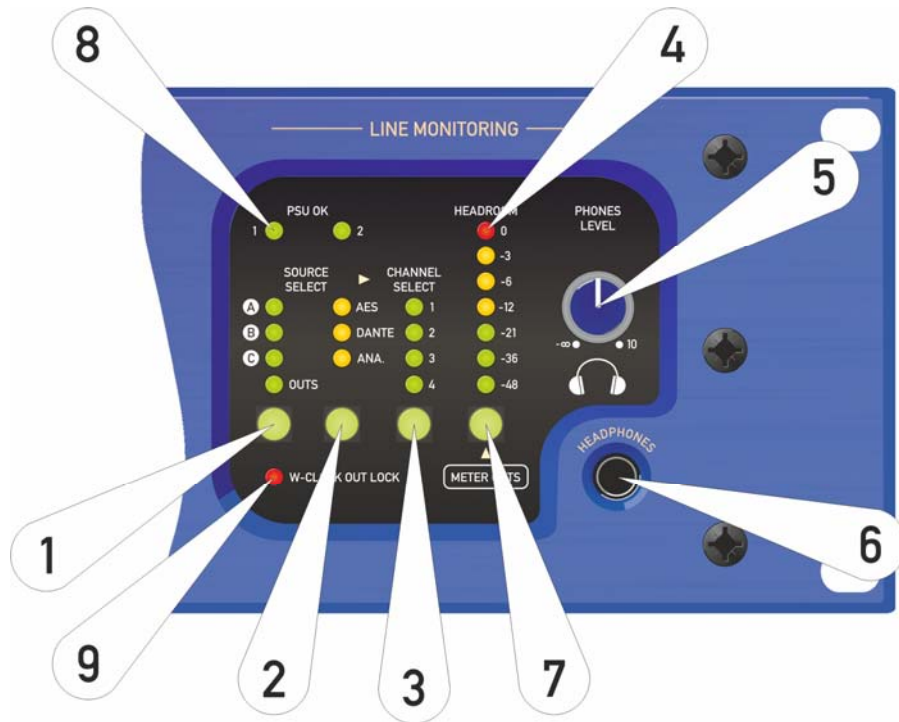

5: Headphone Level Control: The headphone output is mono and controlled by this rotary.

6: Headphones Socket: This is a stereo socket but headphone output is mono – please use a stereo jack to ensure the output is not shorted to ground.

7: Meter Outs: This temporarily swaps the centre columns of LEDs in the Input/Backup Source Select section to show the levels on the four main outputs, using the scaling shown in the boxed legend. The blue switch LEDs will extinguish to show that this mode is active. Pressing any source/backup select button or the Meter Outs button again will cancel this.

8: PSU OK LEDs: Confirmation of the internal supplies being connected and functioning is shown. If the LED is extinguished, the supply has not been connected. If the LED is flashing then the supply has been connected but is now not functioning or has become disconnected.

9: External Word Clock Out Lock LED: If this is illuminated then a valid word clock signal is present on the BNC connector and this is being used to sync the AES outputs ONLY (AES inputs all have independent sample rate converters). If this is not illuminated, then no valid WCLK has been present since power up. If it is flashing, then previously valid WCLK has been lost.

Outside Your MX36: Rear Panel Connections

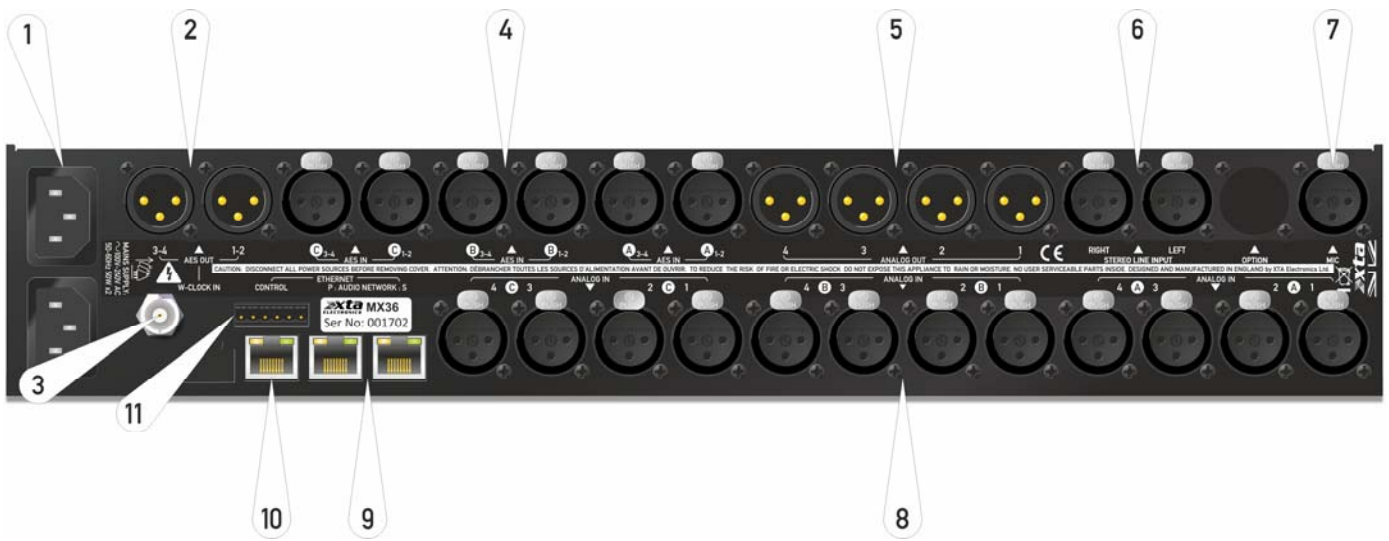

1: Mains Inlets: The IEC mains inlets are unswitched, and feed two independent power supplies operating in redundancy mode. Either power supply is capable of powering the entire unit indefinitely, but we recommend using both, connected to different mains circuits in mission-critical situations!

2: Main AES Outputs: These two XLRs carry the four main output channels as two AES pairs formatted as 1+2 and 3+4.

3: AES Outputs Wordclock Sync Input: Connect an external wordclock source to synchronise the AES outputs. Front panel LED shows when valid clock is present and in use.

4: A/B/C AES Inputs: Digital audio inputs arranged in three groups of two pairs each for A, B and C sets; 1+2, 3+4. Independent sample rate conversion on every input socket.

5: Main analogue output XLR sockets: These carry the four main output channels - the sum of the A-B-C console selects.

6: Stereo Line Input: This pair of XLRs is a balanced stereo input is mirrored on the front panel with an unbalanced 3.5mm stereo jack (unbalanced) run in parallel. Use to connect a laptop or mobile sound source for background music feeds, or even another analogue stereo console.

7: Microphone Input: Plug in a balanced mic to use for announcements – this socket is mirrored on the front panel (both sockets are connected in parallel).

8: A/B/C Analogue Inputs: Balanced inputs arranged in three groups of four each for A, B and C sets.

9: Dante Primary and Secondary Ports: Networked audio connections – 1: Primary, 2: Secondary. See page 44 for details of Dante I-O channel mapping.

10: Control Ethernet Port: Connection to this port is currently limited to firmware updates only.

11: GPIO Port: External trigger inputs for voice evacuation systems to route microphone and/or stereo line input to main outputs. See page 29 for more information.

Inside Your MX36: Configurations and Routing

Overview of Audio Routing

The MX36 offers three sets four inputs, each of which can be analogue, AES or Dante audio.

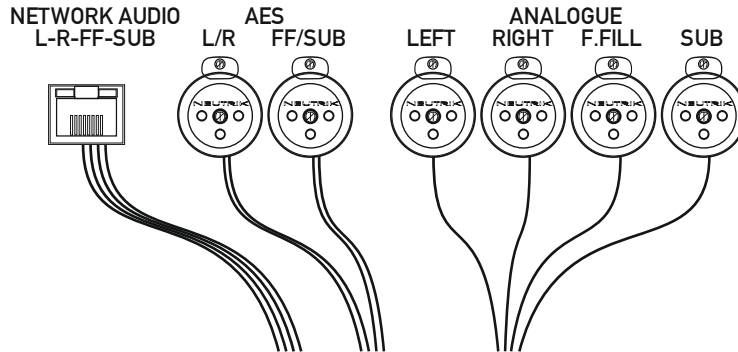

These are designated as sets A, B and C, and each set can switch automatically between either the analogue, AES or Dante inputs, depending on the settings of the front panel source selection.

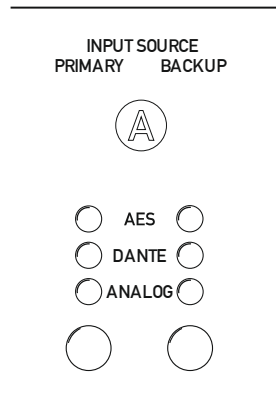

The “output” of each of the sets is controlled by the set of three console switching selectors on the front panel which will then route these onto the main four-channel output bus.

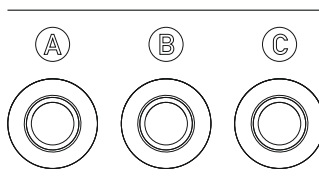

The output bus is available simultaneously as four analogue outputs, a pair of two channel AES outputs, and four transmitter channels on the Dante network.

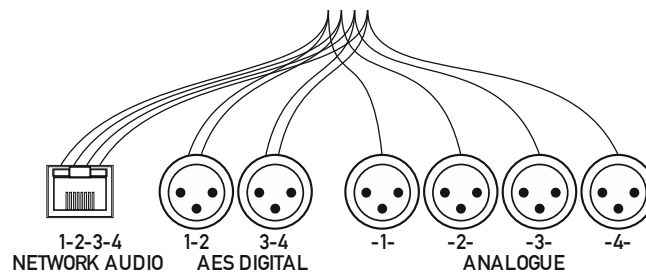

Additionally, there is a stereo line input (unbalanced front 3.5mm stereo jack in parallel with balanced rear panel XLRs) which can be routed to either outputs 1+2, 3+4 or both pairs. It can also be fed in mono to outputs 3+4.

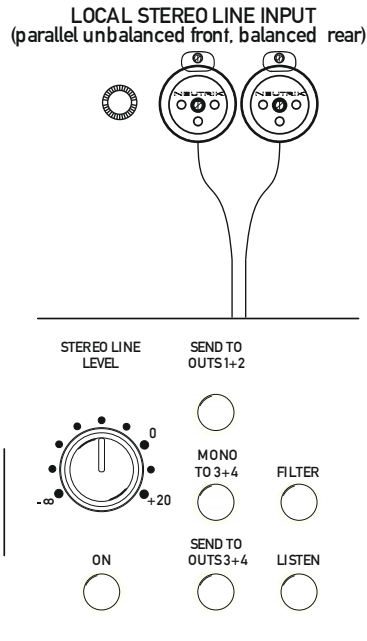

Finally, a high quality microphone preamp is provided with flexible routing to a variety of output combinations. There are front and rear fully balanced connections, with 48V phantom power.

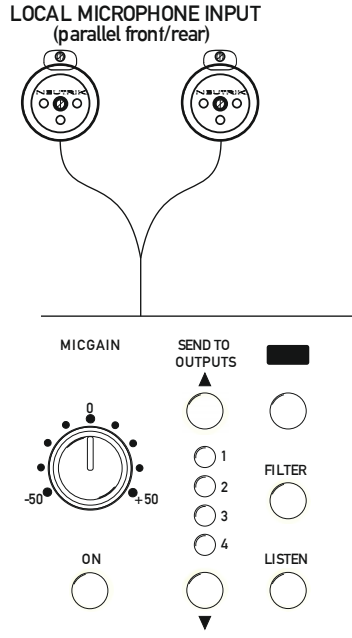

Operating Your MX36: Working with Failover and Redundancy

The MX36 is capable of operating with up to 3 levels of redundancy on any of the three main quad channel input sets. There are therefore 36 channels available (3 x source type x 4 channels x 3 sets = 36).

The priority of the input sources is chosen for each set using the Input Source / Backup keys for each of banks A, B & C. Analogue is always the lowest priority - your “if all else fails” option. If a Dante subscription is removed or the network is lost, the MX36 will switch to the backup (normally AES). If AES is lost then the MX36 will switch to the Analogue (on a 4 channel basis to maintain latency timings).

Working in this full redundancy/failover mode, the MX36 will handle three sets x four channels (typically Left, Right, Front Fill, Sub).

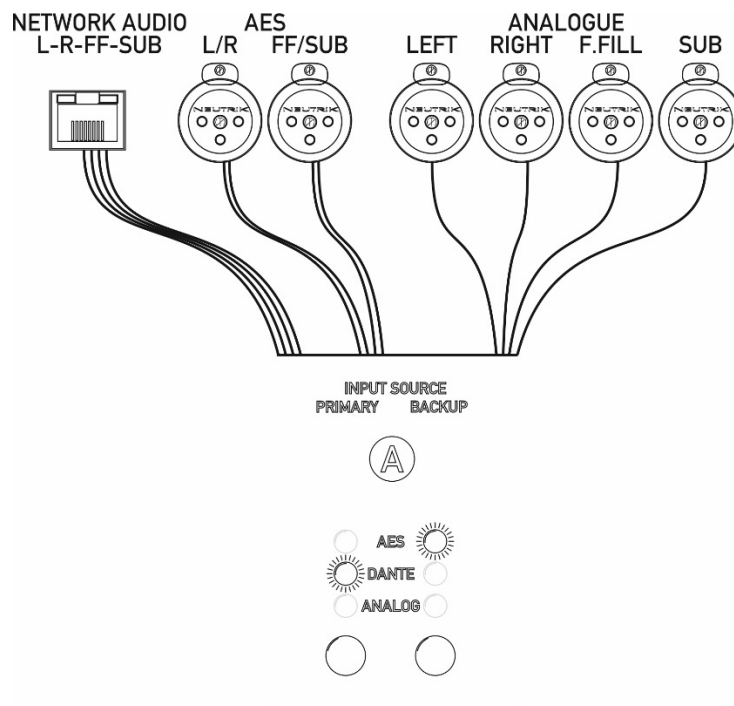

Not all consoles will provide all three source types, so the Input Source Priority should be set accordingly – if only Analogue and AES is available then the typical setting would be Primary = AES and Backup = Analogue.

If only a single source type is available then redundancy can simply be switched off – for example, if only AES is available then Primary = AES and Backup = OFF.

Operating Your MX36: With and/or Without Redundancy

Each of the three “sets” of four inputs can be considered as having a switched sub-mixer to select either the Dante streams, the AES pairs or the analogue inputs for the quad mix that appears at the “top” of the console select switch, A, B or C. The switched sub-mixer can either be used automatically (so with redundancy/failover) where the MX36 decides what selection to use based on the Primary and Backup settings chosen, or, if redundancy is disabled (so either Primary = Analogue, or Backup = OFF), then the Primary selection manually determines which source appears at the “top” of the console select switch.

Example Setup

Consider a scenario where there is a warm-up act, support, and the main act.

The warm-up is a singer with an acoustic guitar, mixed on-stage with a small analogue desk. This is connected to the analogue inputs for set C, and the INPUT SOURCE PRIMARY set to ANALOG. Note that selecting analogue as the primary source will automatically disable the choice of a backup source, and the button for BACKUP will extinguish.

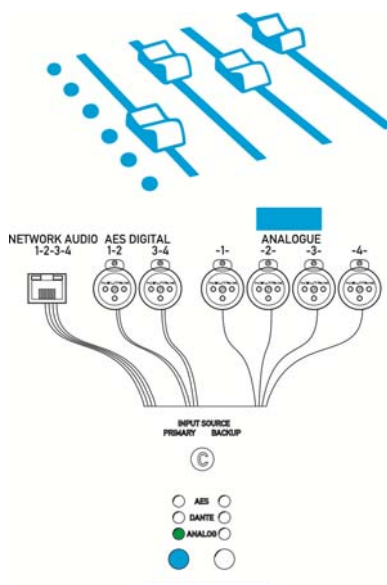
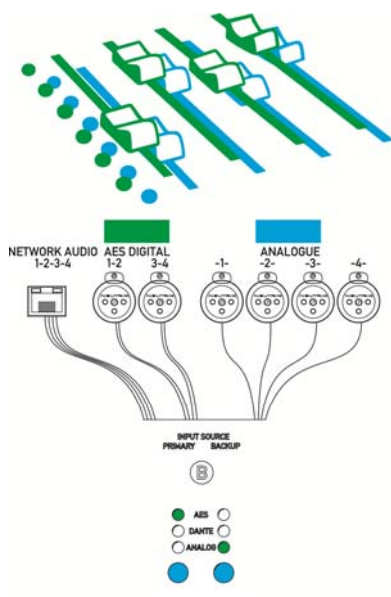

The support is a full band with small format digital desk which also has AES outputs. Making use of both the analogue and digital outputs, they are connected to set B, and the INPUT SOURCE PRIMARY set to AES. To use the analogue inputs as the fallover source, the INPUT SOURCE BACKUP is set to ANALOG.

The main act use a digital console with a Dante card fitted and also supporting AES and analogue outputs. For the main act, all three sources are utilised so there are two levels of failover, Dante > AES > Analogue.

INPUT SOURCE PRIMARY is set to DANTE, BACKUP is set to AES and , in this mode, ANALOGUE is automatically chosen as the third failover source.

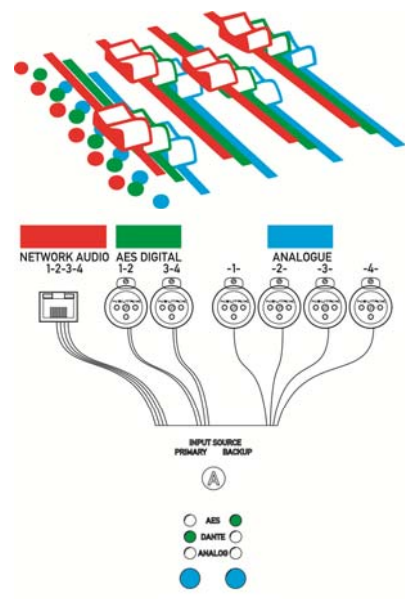

Conditions That Trigger a Source Change in Redundancy Mode

If using Dante, then obviously if the audio network cable is disconnected, the unit will switch to the backup source, and indicate this by flashing the Primary or Backup selector button for the appropriate set A/B/C and the source LED like this:

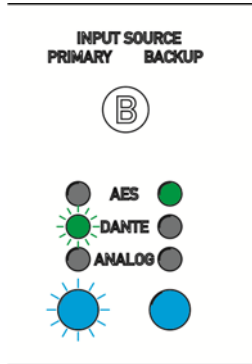

All four Dante inputs in a set MUST have a subscription for the unit to consider this as valid signal conditions. If any channel of the set has its subscription removed (it can be changed but not removed) then all four are considered as lost and the unit will switch the set to the backup source (if one is selected).

In AES mode, the same holds true but for pairs of AES inputs – BOTH AES streams (forming the four inputs) must have a valid AES streams – loss of clock, or validity, parity or non-audio flags or physical disconnection of EITHER stream will be seen as source lost and the unit will switch the set to the backup source. It will indicate the loss by flashing the Primary or Backup selector button and the AES LED.

In the case of losing both Dante and AES (and so automatically selecting Analogue), both the Primary and Backup source selector buttons will be flashing like this:

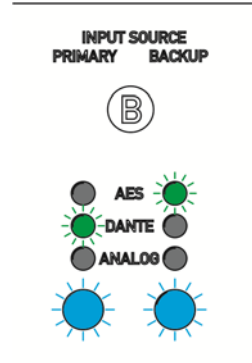

If a Source is Restored...

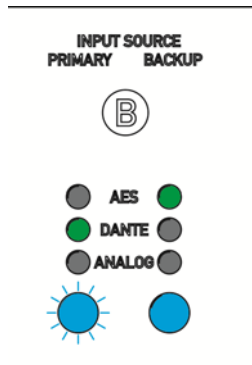

If the source is restored, the source LED will stop flashing, but the button will continue to do so, indicating that it must be pressed to reselect this source manually. The unit will NOT automatically switch back to the higher priority source by default¹.

Pressing the flashing source button will reselect this as the current source and the button will stop flashing.

The main point to remember is that if nothing is flashing, all sources are good and the primary choice is in use!

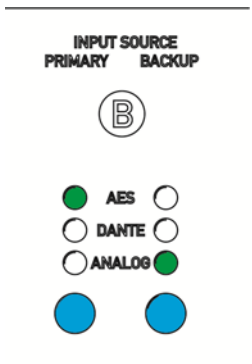

¹ This default mode of operation will be adjustable in a future firmware release to allow for automatic reselection of restored sources.

Working without Redundancy

If alternate signal formats are not available for your sources, the unit can be run entirely without redundancy or of course it can be mixed - some sets with or without as explained the previous example on page 25.

If redundancy is not being used, the other inputs can be used to operate the unit in a different way, and to simply switch between more sets of four channels, allowing connection of up to 9 x 4 channel sources (assuming 3 of each in analogue/AES/ Dante).

Backup sources are disabled (via the front panel – Backup = Off) and the Primary source switching is used to cycle between the three signal types to select one of three consoles.

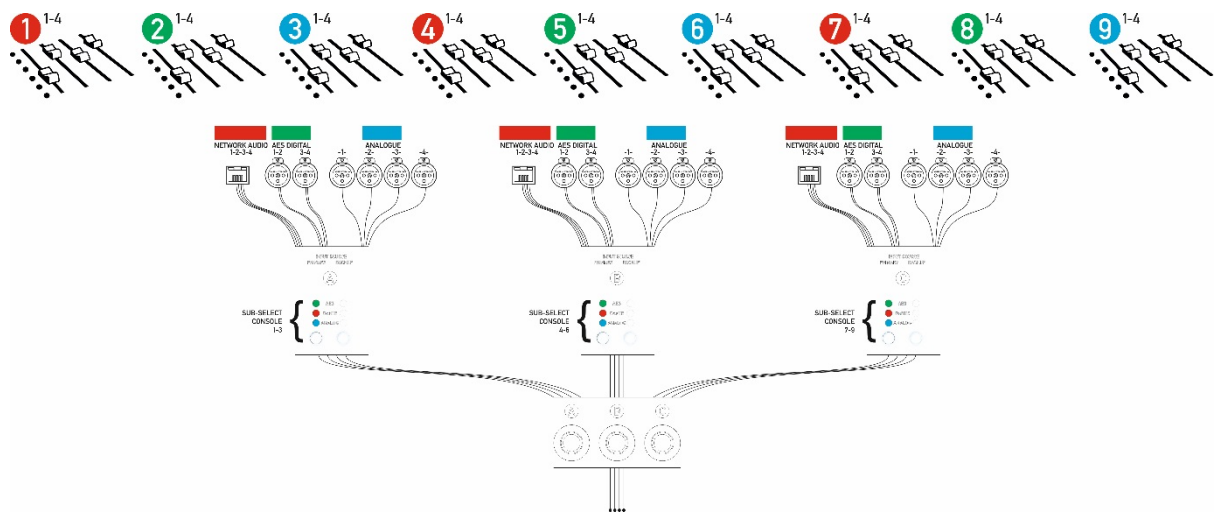

Operating Your MX36: Headroom Monitoring System

With up to 36 possible sources connected, monitoring them all would be virtually impossible, so the MX36 takes care of this by watching all incoming levels on all formats and alerting you to any channels that are close to running out of headroom.

As previously explained, the LINE MONITORING section on the front panel allows any individual channel to be selected and auditioned via headphones, and the high resolution headroom meter shows the level on the chosen channel.

In the background, the unit is also monitoring all other channels, and if any peak at within 2dB of the headroom ceiling (so on an analogue channel this is +20dBu), the red LED at the top of the meter will begin to flash, irrespective of what the rest of the meter is showing.



The attack time on this monitoring is instantaneous, but it has a 3 second hold time so even the shortest peaks will be caught and displayed. To determine which channel (or channels) have hit the threshold, cycle through all connected channels until the meter shows full scale flashing in time with the red LED. In this example it's analogue channel 2 on set A.



Remember, this is not showing that the unit is clipping – it's an alert to turn down any incoming source level that is close to clipping. The MX36 has output limiters to prevent it from generating a clipped output no matter how many sources are selected.

Operating Your MX36: GPI Configuration for Voice Evac. Systems

The MX36 has two general purpose inputs that are configurable to either mute the main outputs or route the microphone or stereo line input to selected main outputs.

Configuring the GPI port

Connect the MX36 to the network via its CONTROL Ethernet port, and run the utility app – if it's the first time it has run, Windows will ask about allowing it through the firewall – be sure to tick **all** options before pressing "Allow Access".

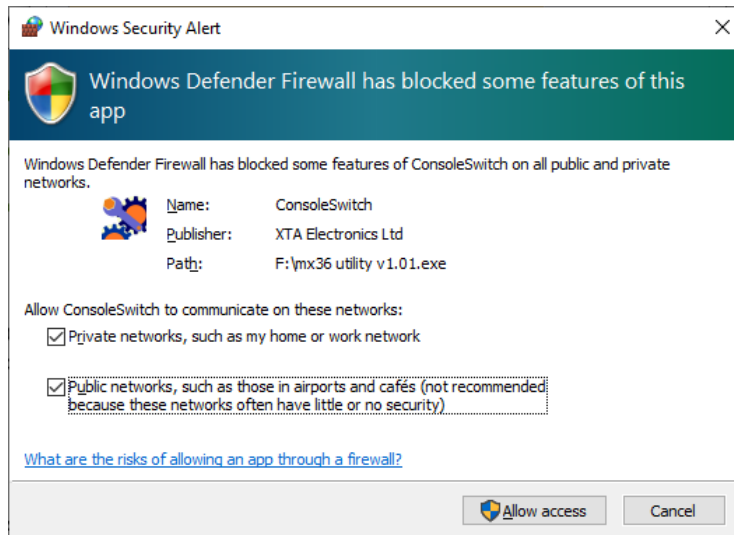

Your MX36 should then be located on your network:

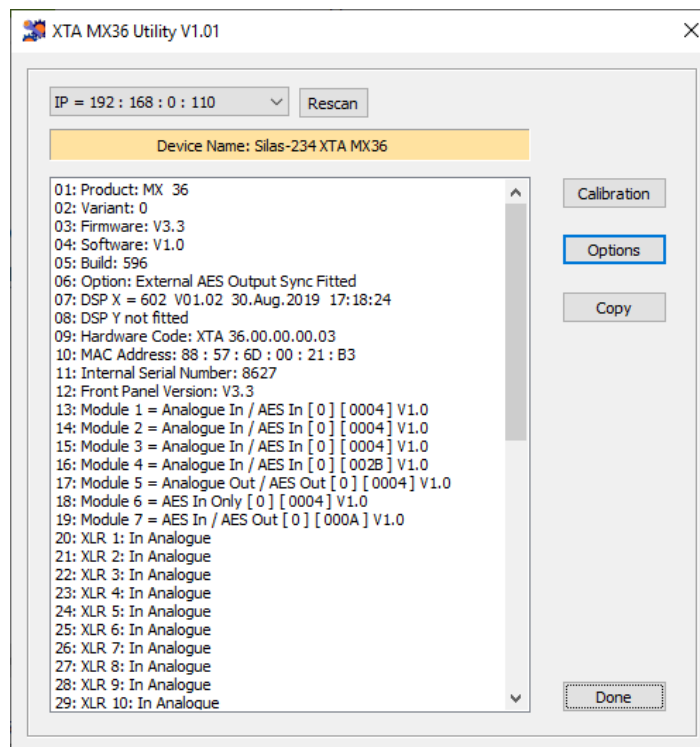

Press the "Options" button to access some configuration choices as shown overleaf:



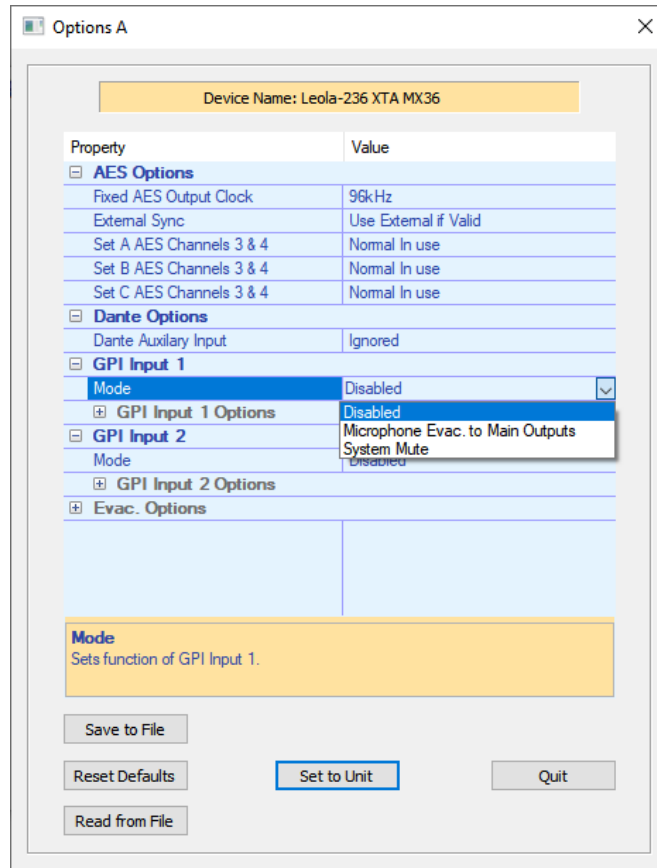

GPI Input 1 can be configured to either provide a system mute of the main outputs, or to route the mic input to selected outputs.

Choose “Microphone Evac. To Main Outputs” to access the other available options as per the front panel, so the mic gain, the filter setting, 48V and the routing required.

The line input is similarly configured for use with the GPI Input 2.

The time to fade down the current console selection setting can also be preset from 0.5 seconds to 10 seconds in the “Evac. Options” section.

If both the Microphone and Stereo Line inputs are configured to be GPI triggered, it is possible to force the Mic on GPI Input 1 to be higher priority if required, also under the “Evac. Options”.

Once everything is set up as required, press “Set to Unit” and these settings will take effect – all parameters configure will immediately be updated and show on the front panel (apart from the gain knob which won’t move!).

Note that configuration of the Mic or Line inputs for voice evac purposes disables the front panel controls for that section.

Connecting to the GPI port

Connect to pin 2 for the microphone trigger or system mute trigger (depending on the configuration chosen), or pin 3 for the line in trigger.

Isolated connections should be between the input pin and 0V to trigger, and +5V to clear.

Non-isolated connections should pull the input pin to 0V to trigger and pull up to a maximum voltage of +15V to clear. Make sure the ground (0V) is connected for reliable operation.

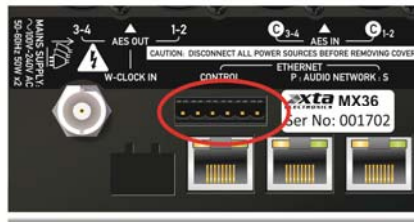
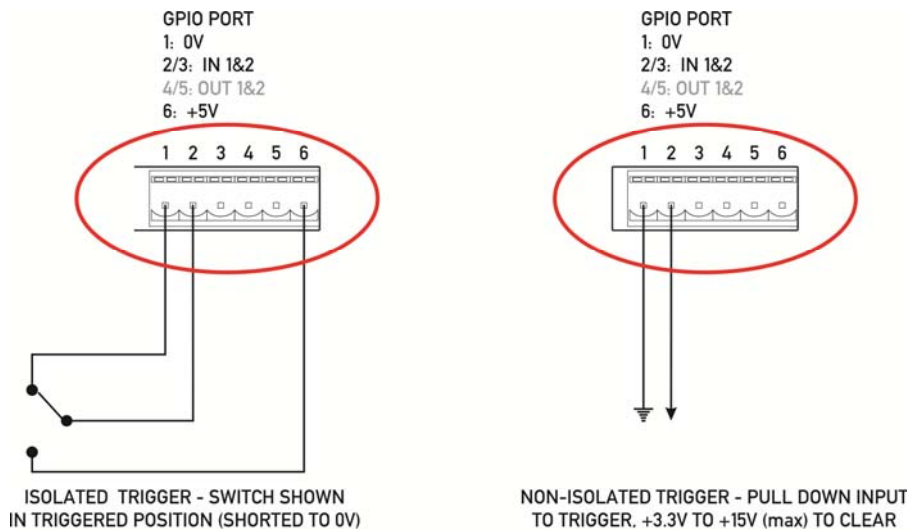

When triggered, the “padlock” LEDs will flash, and the “ON” button of the triggered input. If the padlock LEDs flash on their own, this signifies a “System Mute”.

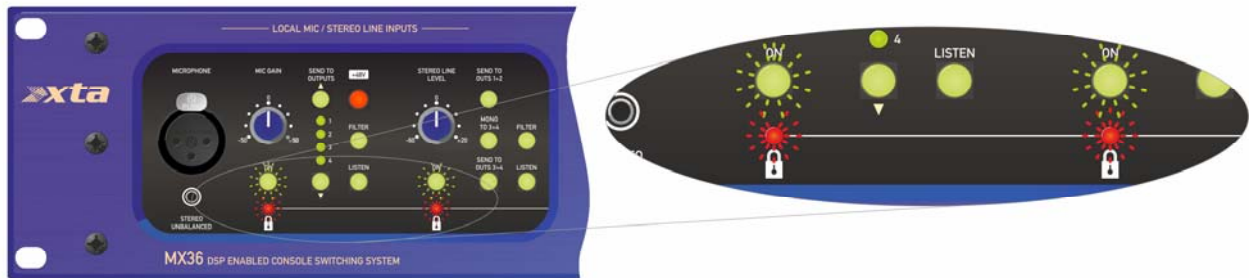

Operating Your MX36: Increase Console Capacity with Cascade Mode

If it is necessary to manage more than three consoles that require redundant failover support, units can be connected in cascade. This requires an audio network connection from all units (even if Dante is not being used as a source type by any of the consoles).

The Dante (audio network) connection is required as the Dante outputs from one unit must be connected to the auxiliary (Aux) Dante inputs of the next unit so that the final unit in the cascade can provide a single set of four outputs from all consoles connected to any unit.

The control network connection is required to send switching information (locking, solo etc.) between units.

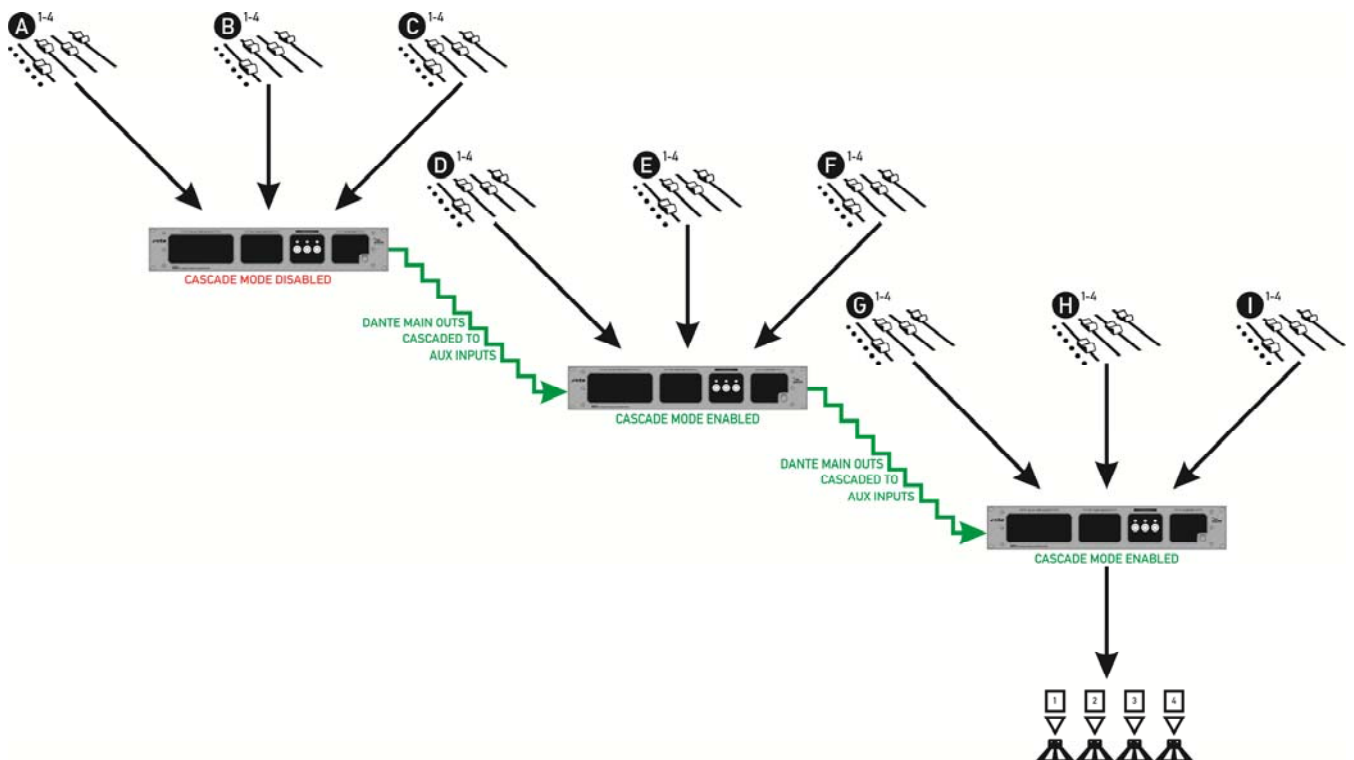

The Console Select switches and failover source selection remain independent on each unit but the use of the Dante Aux bus means that all consoles' audio is output from the unit designated as the master. The set-up of the Aux bus to provide this routing is simply achieved through Dante Controller.

As the stereo line input and mic channels are only ever routed direct to the main outputs, these will also cascade across all *upstream* units.

By default, units are not enabled for cascading – the Dante Aux bus is muted in DSP for safety to prevent any accidental connections through Dante Controller direct to the outputs that would bypass the Console Select function.

Monitoring remains independent on each unit, but the monitor bus is available independently over Dante.

Configuring Cascade Mode within Dante Controller

In this example three units are cascaded to give allow up to nine consoles to be connected to a single set of outputs, all with full redundancy if required.

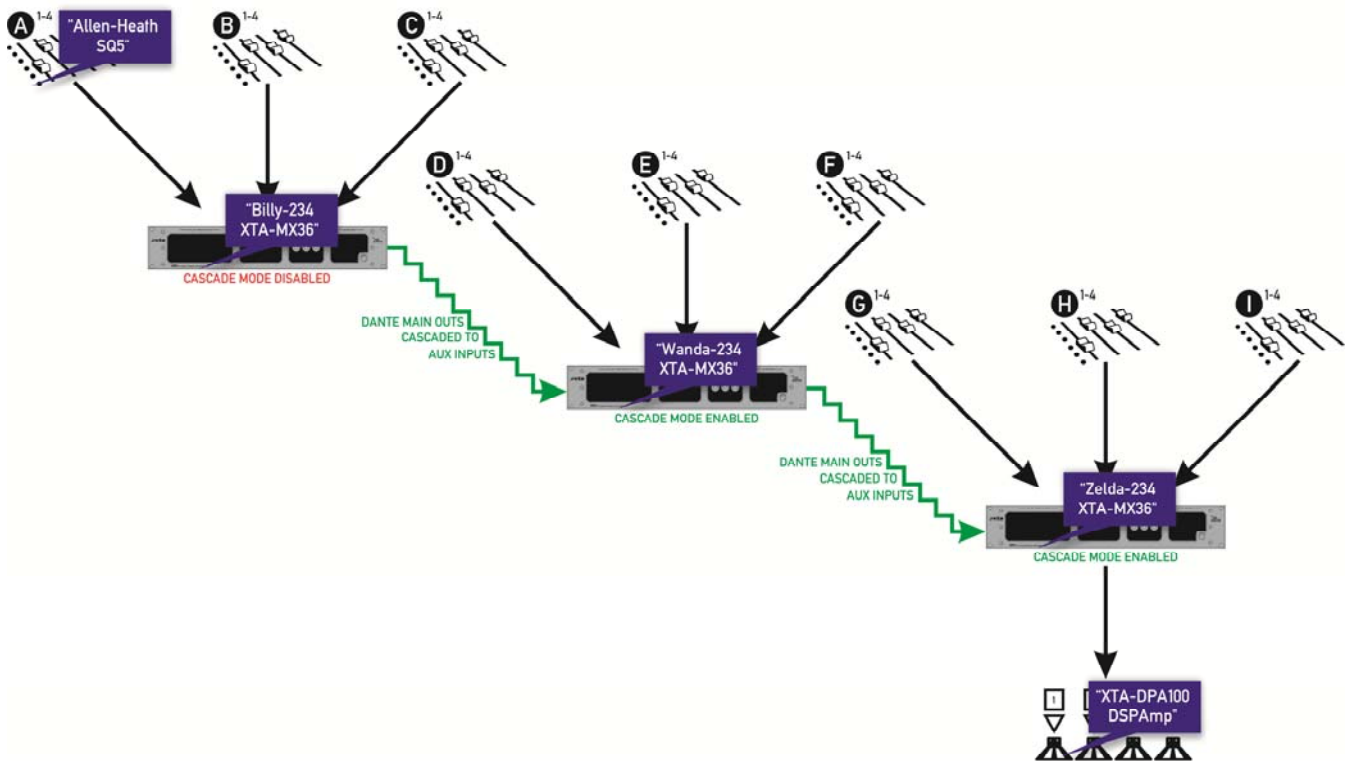

To help illustrate the cascaded method of connection, as it is virtual, not physical, a single mixing console is connected to the system as a four channel input source, and a single DSP amplifier is connected as a four channel output source.

- The Allen and Heath SQ5 is connected to Input A's Dante source connection on Billy. The main outputs of Billy are connected to the Aux bus of Wanda. Now, any desks plugged into Billy and selected via the Console Selects will be summed to the main outputs of Wanda, along with anything selected on Wanda's Console Selects.
- The main outputs of Wanda are connected to the Aux bus of Zelda. Now, any of the desks connected to either Billy or Wanda will be summed with Console Selects on Zelda, and all fed to the main outputs on Zelda.
- Zelda, the last MX36 in the cascade is then connected via the main outputs to the upstream processor or in this example, a DSP Amp – the XTA DPA100.

Setting this up does not mean physical Dante connections *directly between* the devices, they all just have to be connected to the same network, and all the configuration is performed in Dante Controller, as shown overleaf.

Dante

Filter Transmitters:

Filter Receivers:

Dante Transmitters

- Allen-Heath-SQ5
 - OutNet 1
 - OutNet 2
 - OutNet 3
 - OutNet 4
- Billy-234-XTA-MX36
 - Output Ch 1
 - Output Ch 2
 - Output Ch 3
 - Output Ch 4
 - Output Mic
 - Output Line L
 - Output Line R
 - Output Monitor
- Wanda-234-XTA-MX36
 - Output Ch 1
 - Output Ch 2
 - Output Ch 3
 - Output Ch 4
 - Output Mic
 - Output Line L
 - Output Line R
 - Output Monitor
- XTA-DPA100-DSPamp
 - OutNet 1
 - OutNet 2
 - OutNet 3
 - OutNet 4
- Zelda-234-XTA-MX36
 - Output Ch 1
 - Output Ch 2
 - Output Ch 3
 - Output Ch 4
 - Output Mic

Dante Receivers

- Allen-Heath-SQ5
 - InNet A
 - InNet B
 - InNet C
 - InNet D
- Billy-234-XTA-MX36
 - Input A Ch 1
 - Input A Ch 2
 - Input A Ch 3
 - Input A Ch 4
 - Input B Ch 1
 - Input B Ch 2
 - Input B Ch 3
 - Input B Ch 4
 - Input C Ch 1
 - Input C Ch 2
 - Input C Ch 3
 - Input C Ch 4
 - Input Aux Ch 1
 - Input Aux Ch 2
 - Input Aux Ch 3
 - Input Aux Ch 4
- Wanda-234-XTA-MX36
 - Input A Ch 1
 - Input A Ch 2
 - Input A Ch 3
 - Input A Ch 4
 - Input B Ch 1
 - Input B Ch 2
 - Input B Ch 3
 - Input B Ch 4
 - Input C Ch 1
 - Input C Ch 2
 - Input C Ch 3
 - Input C Ch 4
 - Input Aux Ch 1
 - Input Aux Ch 2
 - Input Aux Ch 3
 - Input Aux Ch 4
- Zelda-234-XTA-MX36
 - Input A Ch 1
 - Input A Ch 2
 - Input A Ch 3
 - Input A Ch 4
 - Input B Ch 1
 - Input B Ch 2
 - Input B Ch 3
 - Input B Ch 4
 - Input C Ch 1
 - Input C Ch 2
 - Input C Ch 3
 - Input C Ch 4
 - Input Aux Ch 1
 - Input Aux Ch 2
 - Input Aux Ch 3
 - Input Aux Ch 4
- XTA-DPA100-DSPamp
 - InNet A
 - InNet B
 - InNet C
 - InNet D

Receiver	Allen-Heath-SQ5	Billy-234-XTA-MX36	Wanda-234-XTA-MX36	XTA-DPA100-DSPamp	Zelda-234-XTA-MX36
Allen-Heath-SQ5					
Billy-234-XTA-MX36	✓	✓			
Wanda-234-XTA-MX36		✓	✓		
Zelda-234-XTA-MX36				✓	
XTA-DPA100-DSPamp					✓



Don't forget that ALL the units upstream of the first unit need to have Cascade Mode enabled, and this is performed using the MX36 Utility app.

This mode unmutes the Aux bus to allow it to feed the main outputs of the unit. Note that in Dante controller, the Aux output bus is always displayed, even if it is muted. Connect the MX36 to the network via its CONTROL Ethernet port, and run the utility app – if it's the first time it has run, Windows will ask about allowing it through the firewall – be sure to tick **all** options before pressing "Allow Access".

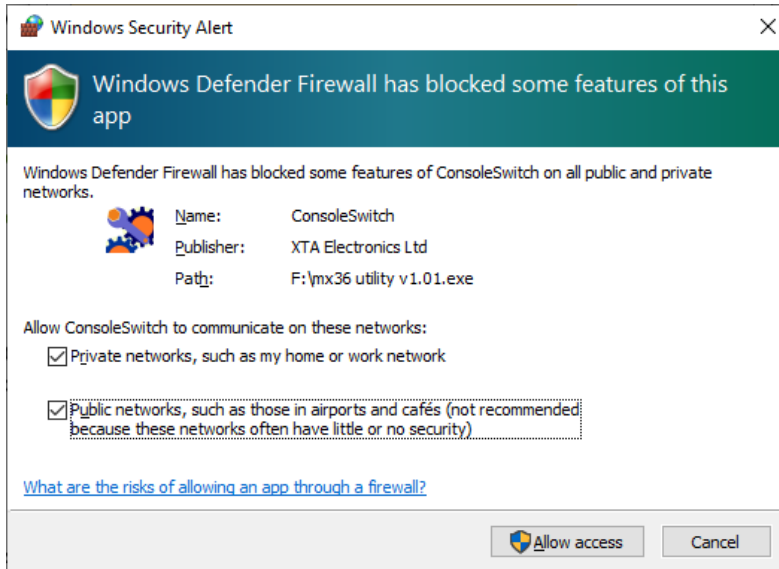

Your MX36 should then be located on your network:

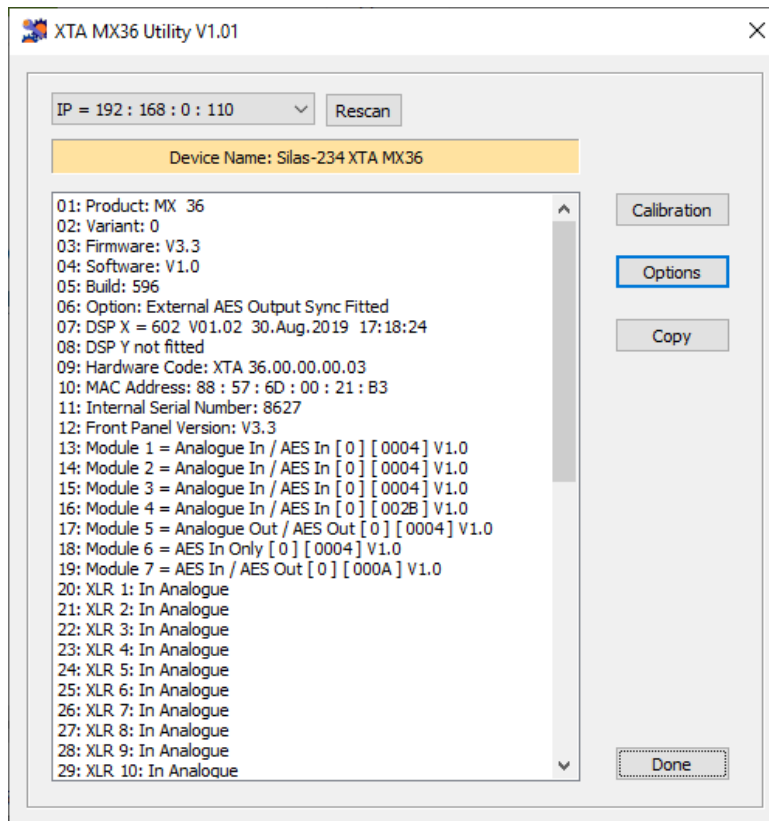

Press the "Options" button to access some configuration choices as shown overleaf:

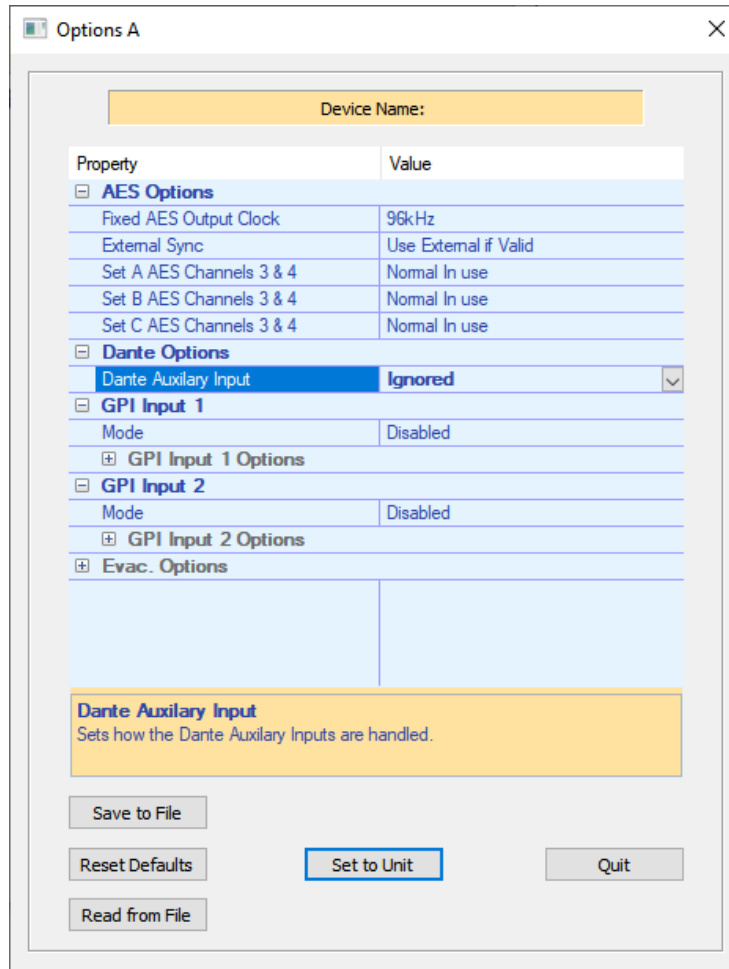

By default the Dante Aux. Inputs will be ignored as above. Change this drop-down list to "Routed to Main Outputs" as below:

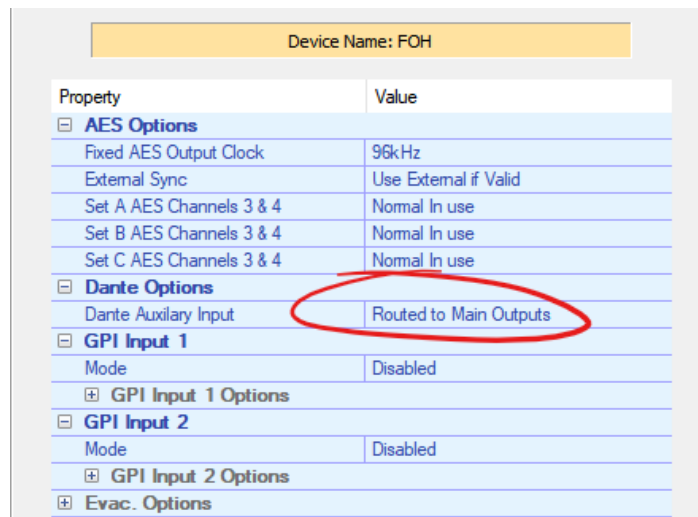

Press "Set & Save" and then close the application. Now, anything routed via Dante controller to the Receiver Aux inputs on the unit will immediately be passed through to the main outputs, bypassing the CONSOLE SELECT buttons.

Operating Your MX36: Increase Channel Capacity with Parallel Mode

If it is necessary to manage more than four outputs per console and maintain redundant failover support, units can be connected in parallel. This requires a control network connection from all units. Dante connections are not required unless Dante is being used for normal IO connections.

The control network connection is required to send switching information (locking, solo etc.) between both units, as well as Console Select, which is automatically synchronised.

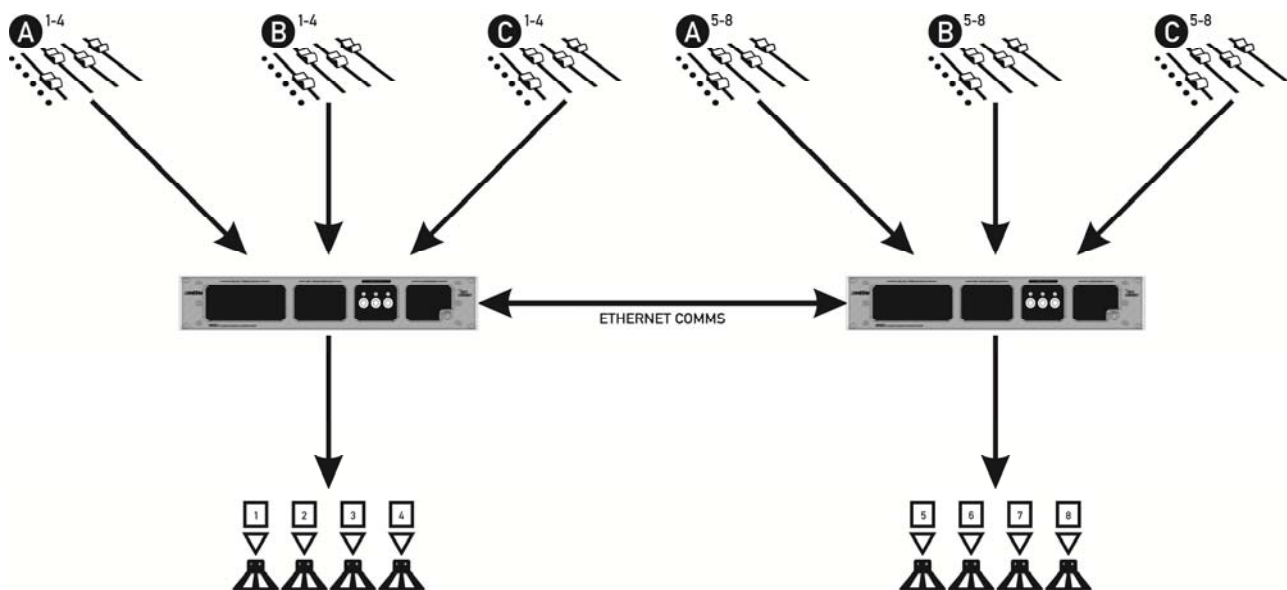

Any redundancy and failover set up on the system will be synchronised across all outputs.

Please note that in this initial firmware release (V1.00), parallel mode is disabled. Parallel mode will be activated in the next feature release of firmware.

Parallel mode can still be set up and used, but the settings of the Console Select and Redundancy sections will have to be manually applied, and failover operation will operate in isolation on each unit.

Looking After Your MX36: Maintenance

The casework of the unit may be cleaned with a lightly dampened cloth – do not use any solvents as they will damage the paint finish and could remove printing.

The unit contains a memory backup battery to maintain current front panel settings when powered down. This is a non-rechargeable coin cell type CRO32 and is fitted to a holder that allows it to be easily replaced without soldering. The battery should last 3 years. All factory calibration settings are stored in Flash ROM and will not be lost should the battery fail.

If you have any doubts about carrying out maintenance, please refer to a service engineer or contact your local dealer.

Looking After Your MX36: Warranty

Your MX36 is guaranteed for a period of five (5) years from the date of manufacture. Please note that this does not apply to OEM versions of the amplifier – please consult your manufacturer for their warranty terms. We hope that it gives you many more years of reliable service than this, but should anything go wrong, please contact us to advise you about repairs or any spares you might require.

Please do not attempt to repair the unit yourself as doing so will invalidate the warranty.

Our contact details are:

XTA Electronics Limited,
The Design House
Vale Business Park
Worcester Road
Stourport on Severn
Worcestershire
England
DY13 9BZ

Tel: +44(0)1299 879977

Fax: +44(0)1299 879969

email: sales@xta.co.uk for general enquiries

Our website is a great place to get started if you have any questions regarding the general use of your unit or need copies of this manual in digital form, or datasheets and photographs.

www.xta.co.uk



Performance Of Your MX36: Specifications

Audio Specifications

Parameter (Units)	MX36
Analogue line inputs (incl stereo line input)	
Channels	(3 x 4) + (1 x 2)
Input impedance (Ohms)	10k
Max input level (dBu)	+22
CMR @ 1kHz (dB)	>50
THD 20-20k (%)	<0.002
Dynamic range typ. (dB)	116
Analogue microphone input	
Channels	1
Input impedance (Ohms)	10k
Max input level (dBu)	+22
Equivalent Input Noise @ 150R Impedance (dBu)	-127
CMR @ 1kHz (dB)	>50
Analogue outputs	
Output source impedance (Ohms)	70
Min load impedance (Ohms)	300
Max output level (dBu)	+22
Dynamic range typ. (dB)	118.5
Headphone output (stereo jack – mono signal)	
Min load impedance/Ch. (Ohms)	8
THD 20-20k (%)	<0.013
Max output power (W)	-1.5
Frequency Response, +0/0.2dB (Hz)	20 – 20k
AES digital outputs	
Channels @ 96kHz (or External clock fs)	2 x 2
Voltage @ 110R termination balanced (V)	2.5
AES digital inputs	
Channels	3 x (2 x 2)
Sample rate (kHz)	44.1 – 192
Sample Rate Converters	6 x 2Ch.
External word clock input²	
Impedance termination (Ohms)	150
Accepted voltage range (V)	0.2 – 7.0
Dante network Audio I-O	
Input channels available	12+4 aux ³
Output channels available	4+4 aux ¹
Sample rates supported (kHz)	48/96

System Specifications

Parameter (Units)	MX36
Mains supply (V AC)	100-240
Power Consumption (W)	<50W ⁴
Dimensions H x W x D (mm)	
Unit (excl. connectors)	88 x 482 x 335
Boxed	230 x 580 x 560
Boxed Shipping – all except UK	250 x 610 x 600
Weight (kgs)	
Unit	5.1
Boxed	6.3

Due to continuing product improvement, the above specifications are subject to change.

² External word clock input is used to synchronise AES outputs only

³ Auxiliary Dante channels are only accessible when units operate in cascade or parallel mode

⁴ Maximum with both PSUs connected

Appendix I: Microphone and Stereo Line Input DSP Filter Responses

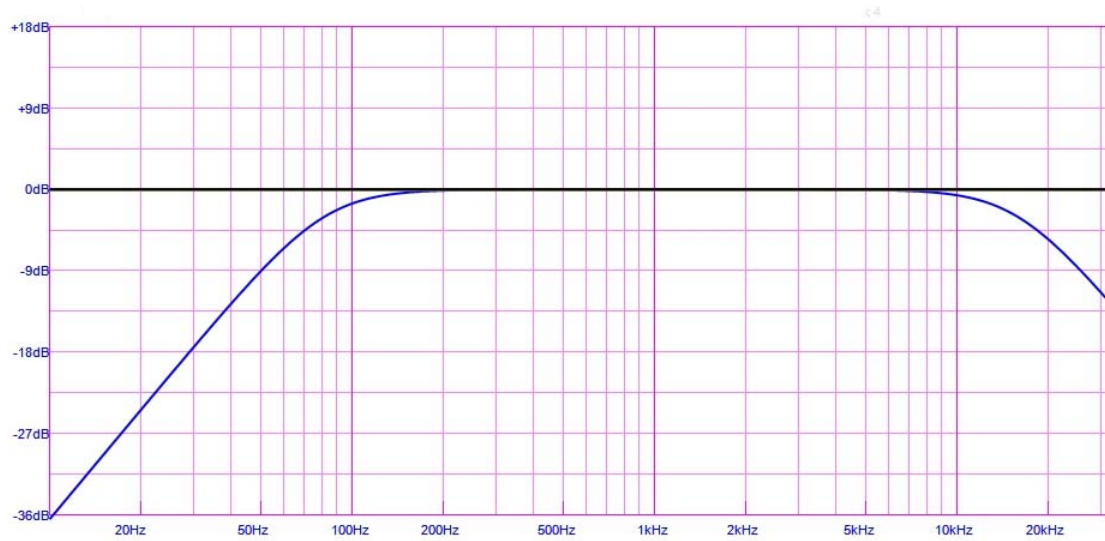

Stereo Line Input:

12dB/Oct. Butterworth HPF @ 80.3Hz;

12dB/Oct. Butterworth LPF @ 16kHz

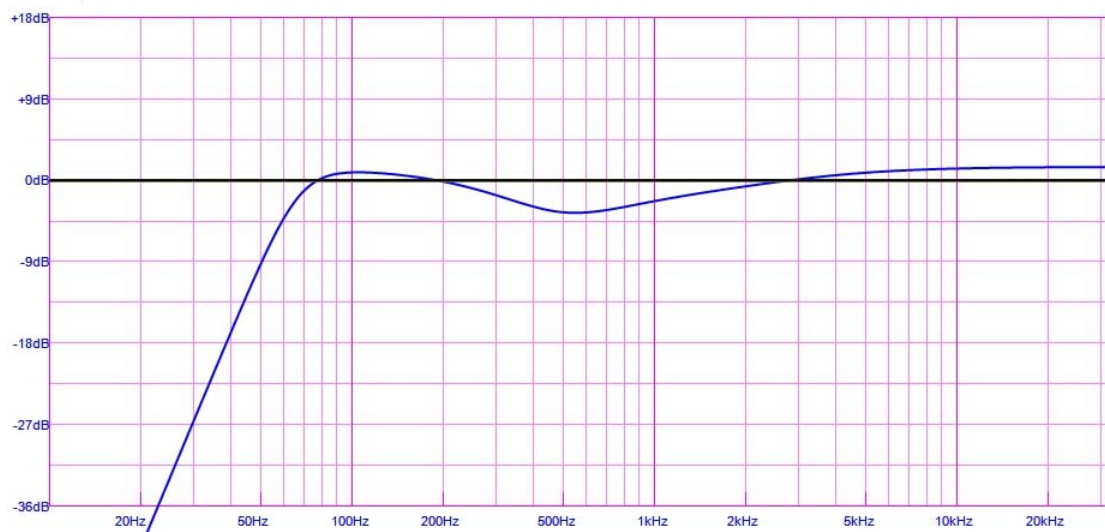

Microphone Input:

24dB/Oct. Butterworth HPF @ 66.2Hz;

500Hz PEQ -3.3dB, Q = 0.84;

1kHz PEQ 2.2dB, Q = 0.4;

Channel gain +1.5dB

Appendix II: Upgrading Firmware

Loading new firmware uses the “Flash Loader” utility that is bundled with the firmware “bin” (binary) file. Firmware (or Program) files have the prefix “LTAM”.

Communications Set-up

Updates can be performed through the Ethernet CONTORL port connection. This is fitted to all versions of MX Series units and is separate to the Dante Audio Ports.

Download the Files

Go to the Support > Latest Software section of the XTA website to find the latest firmware – this will be bundled with the “Flash Loader” application that is used to connect and update your unit.

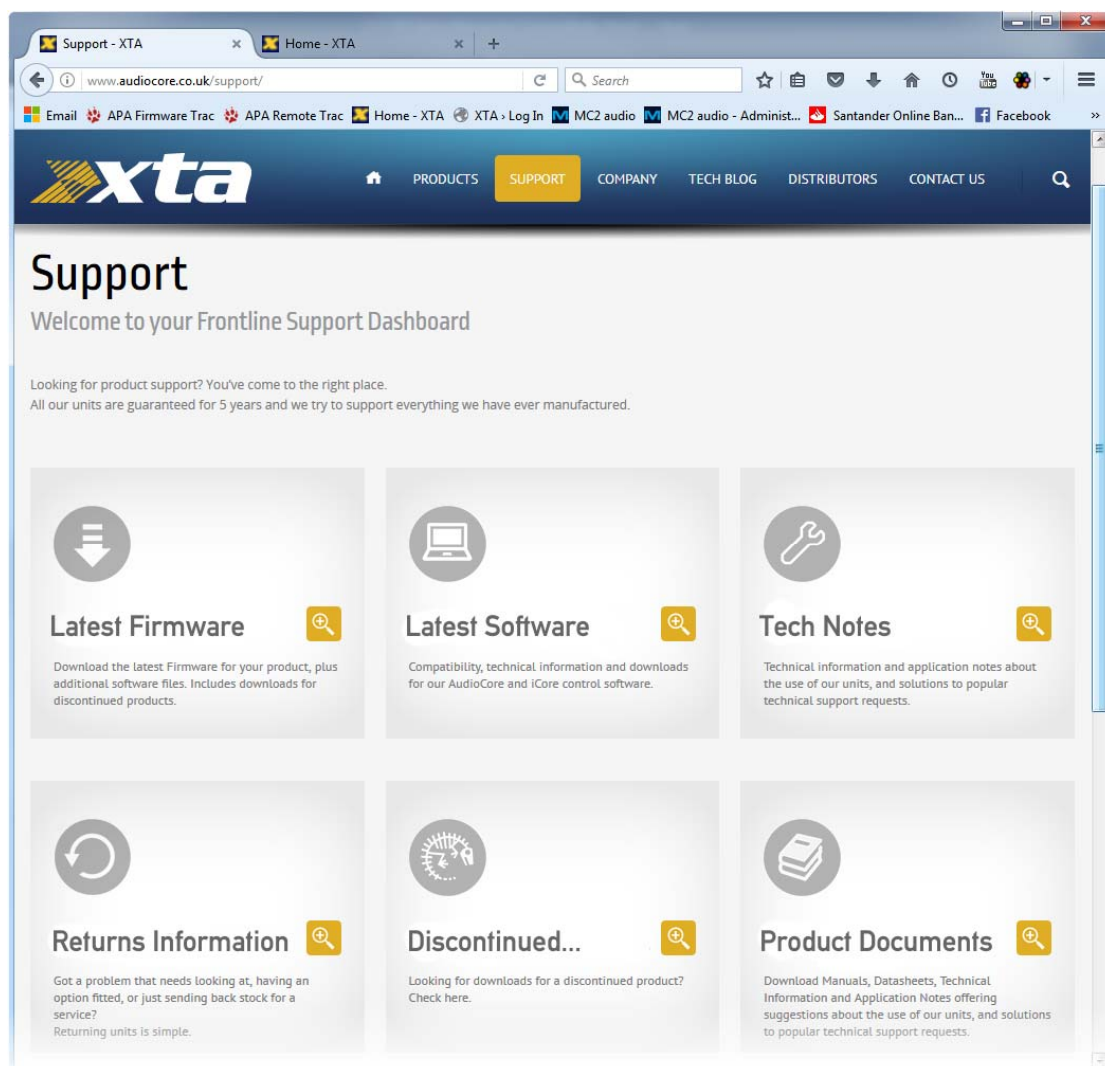

Unzip the files – you will have the loader application, and the firmware file as appropriate.

Connect To The Unit

The loader will detect multiple units, but as there is no way to easily cross-reference IP addresses with physical devices, we recommend only connecting one MX Series unit to the network at a time when performing firmware updates, or power down any other devices temporarily.

Start the loader application:

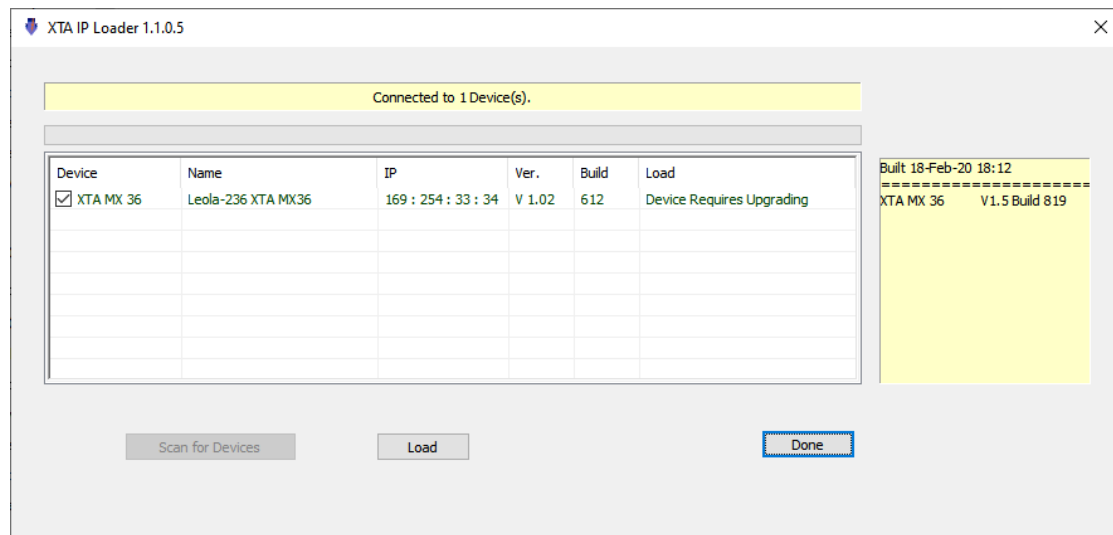

After a few seconds, the unit should be located and its status and type should be displayed, along with the current firmware and some other information.

Start the Update

Just before you press the “Load” button – please close any other applications running on the PC – interruptions in the process could render your unit inoperable. Do not disconnect the cable, turn off the power or attempt to close the loader app once loading has begun!

Now that you have been warned (!) – press the “Load” button, and the unit will mute and begin to load the new firmware.

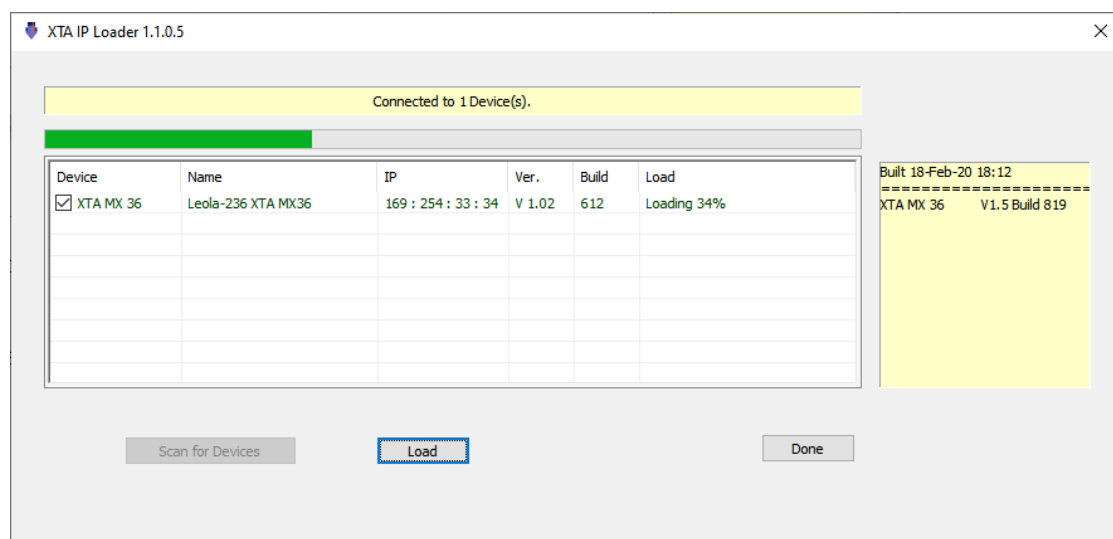

Upon completion, the app will close, and your unit will restart – that’s it!



What If It All Goes Wrong...

Don't panic! Your unit can be recovered, but please be aware that this will involve taking the top cover off and exposing potentially dangerous mains voltages. If you are unsure about doing this, then please do nothing and email us for further information.

Otherwise, disconnect your unit completely from the incoming mains supply.

It is now safe to remove the top cover - be careful not to drop any screws inside!

Locate the "Rescue" link CN1 – between ICs U2 and U3 on the front circuit board - and remove it. This will make your unit run in recovery mode – the original firmware version loaded at the factory will now be active.

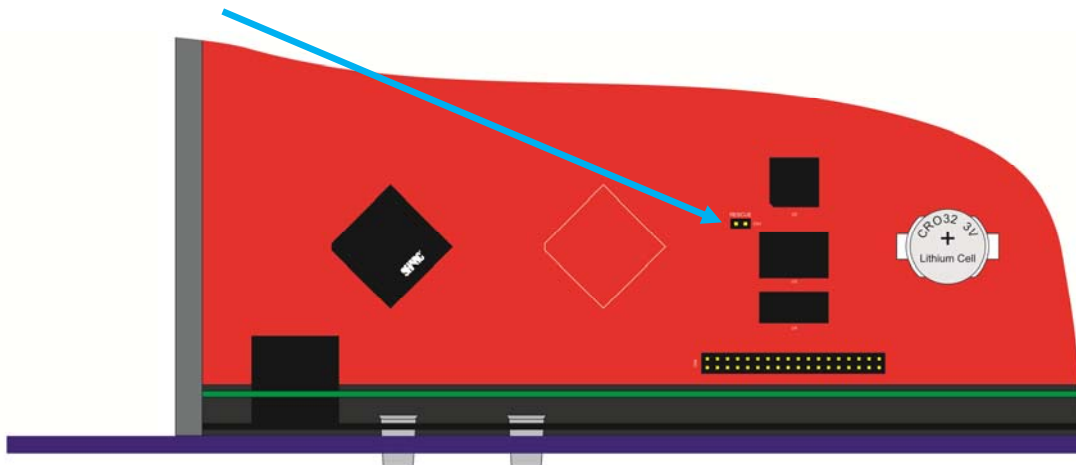

Replace the top cover temporarily, reapply mains power and switch on. Once booted, perform a program update again using the Flash Loader application.

Upon completion, the app will close. Disconnect the power and remove top cover and replace the "Rescue Recovery" link once more.

Replace top cover and screw into place.

Your unit should now be fully operational again – no settings will have been lost in the process.

Appendix III: Dante I-O Channels Mapping

The MX36 appears in Dante Controller as “XTADPC-XXXXX” by default but this can be changed to a more friendly name if required.

Individual receiving channels are labelled as follows:

A

“Input A Ch 1”

“Input A Ch 2”

“Input A Ch 3”

“Input A Ch 4”

B

“Input B Ch 1”

“Input B Ch 2”

“Input B Ch 3”

“Input B Ch 4”

C

“Input C Ch 1”

“Input C Ch 2”

“Input C Ch 3”

“Input C Ch 4”

Individual transmitting channels are labelled as follows:

Main outputs:

“Output Ch 1”

“Output Ch 2”

“Output Ch 3”

“Output Ch 4”

Additionally, there is an auxiliary 4 channel bus which is for use in Cascade and Parallel modes (available in the next feature release of firmware). The transmitter bus is available for routing with the following channels:

“Output Mic” –microphone channel output, post “ON” switching, Filter and Gain

“Output Line L”, “Output Line R” – stereo line channels, post “ON” switching, Filter and Gain

“Output Monitor” – the audio currently on the headphones, pre Level control

The four receiver channels labelled “Input Aux Ch 1” to “Input Aux Ch 4” are currently muted in the MX36, and are reserved for use in the Cascade and Parallel modes.

Appendix IV: AES options configuration

Using the configuration utility, it is possible to change how the MX36 works with AES signals – fix the output sample rate at either 48kHz or 96kHz, and/or disable the external word clock sync input. Additionally, each set of AES inputs for A/B/C can be configured to work in a two channel mode only (so ignoring inputs 3&4 for the purposes of redundancy operation). The signals output from inputs 3&4 can also be changed to be a copy of 1&2 or a sum of 1&2.

Configuring the GPI port

Connect the MX36 to the network via its CONTROL Ethernet port, and run the utility app – if it's the first time it has run, Windows will ask about allowing it through the firewall – be sure to tick **all** options before pressing "Allow Access".

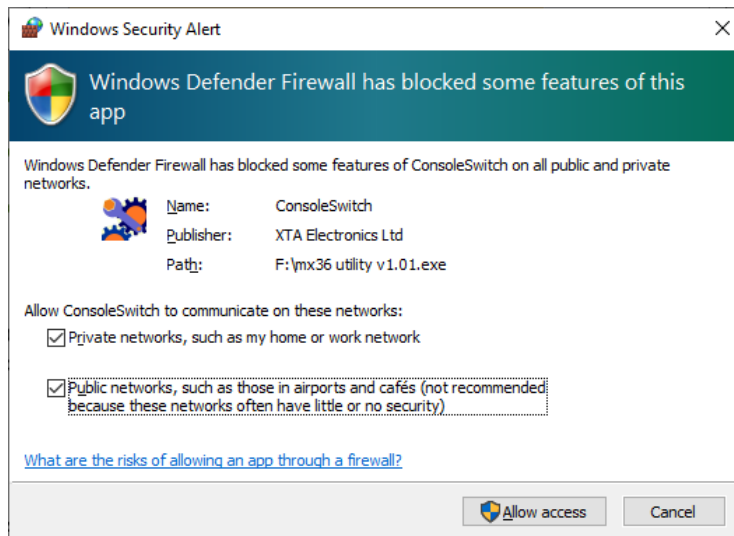

Your MX36 should then be located on your network:

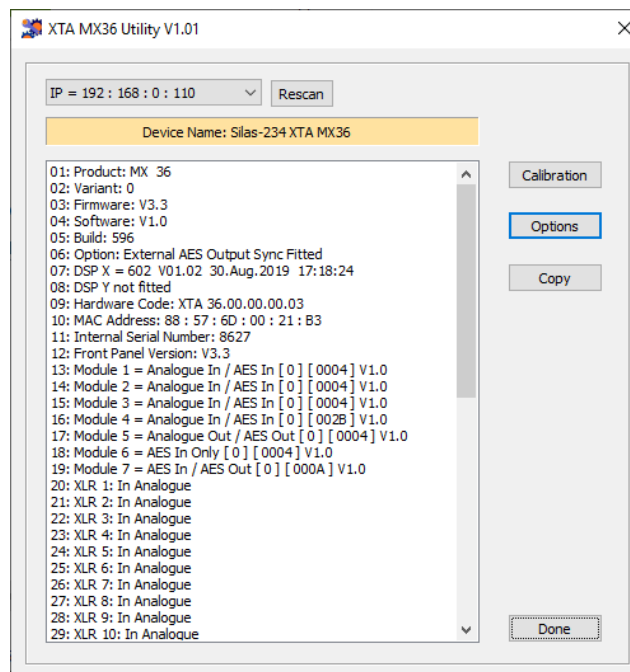

Press the "Options" button to access some configuration choices as shown overleaf:

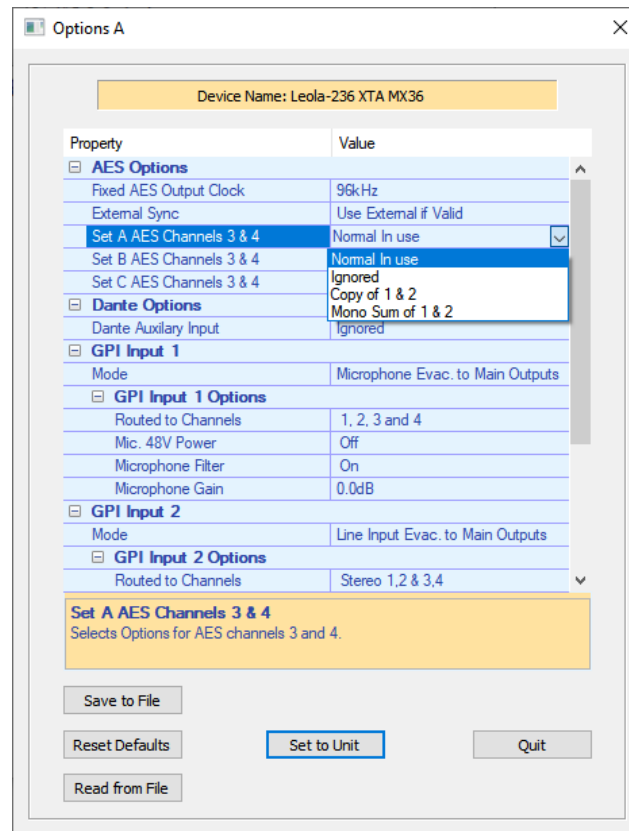

Ignoring channels 3&4 on a set allows the redundancy failover operation to only monitor for a valid AES signal on a set's 1&2 inputs, useful in situations when the console only provides a single AES copy of the main L/R outputs..

Press "Set to Unit" and then close the application.